

ALICLAD MAX



= HORIZONTAL = TIMBER BATTEN

HIGH PERFORMANCE ALUMINIUM
WEATHERBOARD SYSTEM



MATERIALS • SYSTEMS • SOLUTIONS

ALICLAD MAX

The Building Agency is the exclusive distributor of a cultivated selection of well-respected brand name cladding and roofing products and systems.

The Building Agency's focus is to ensure correct and comprehensive selections from our product and system ranges and to assist with design, specification and delivery of high performance buildings.

The Building Agency introduces our newly developed - Aliclad Max System

Performance and aesthetics find a perfect balance in the latest contemporary aluminium cladding system designed in New Zealand for our local conditions.

The tough New Zealand climate calls for exterior products that can perform in all weather conditions, meet the most stringent code and standards, and bring elegance and architectural integrity.

AliClad Max System, designed by The Building Agency, is a premium aluminium weatherboard system that has had every detail and feature designed, tuned and resolved. Backed by decades of local experience and international product knowledge, AliClad Max System offers architects, builders and developers a robust and beautifully finished product, supported on an easy-to-install fixing system engineered to perform.

Designed for large-scale commercial projects with a residential application.
Designed for:

WEATHER-TIGHTNESS: The system has been designed in line with NZBC and been tested to be E2 via NZS4284:2008.

STRUCTURE: The AliClad Max System is designed for buildings in wind zones from Low to Extra High Wind loadings and engineered to be fixed at maximum span distances for easier application and reduced project costs.

FIRE PROTECTION: Aluminium is defined as non-combustible under the NZBC C clause and when correctly specified the support system forms a limited / non-combustible wall assembly. AliClad Max System is tested for buildings over 25m in total height by a full-scale system fire performance test to BR135 and BS8414.

FINISH AND AESTHETICS: Sublimated woodgrains, Flat and matt powdercoat options, Anodised, Anodised-look paint finishes, and horizontal and vertical profile alignments achieve both classic and contemporary designs with ease.



MATERIALS • SYSTEMS • SOLUTIONS

TABLE OF CONTENTS

AliClad Max - Horizontal - Alpha Rail

Information

AC-H-AR-CP - AliClad Max System Compliance Statement
AC-H-AR-Apx.A.T2 - AliClad Max System Appendix A - Table 2 - Fixing
Span Table

Profiles & Accessories

AC-H-AR-PL - AliClad Max System Parts List
AC-H-AR-PRO-01 - AliClad Max System Cladding Profiles
AC-H-AR-PRO-02 - AliClad Max System Trims Profiles
AC-H-AR-MDS - AliClad Max System Mechanical Drainage System Parts

General Processing

AC-H-AR-GP-01 - Cut Board Terminations

TYPICAL DETAILS

1. CORNERS

- 1.1. External Corner
- 1.2. Internal Corner
- 1.3. External Corner - Smaller Cladding Type
- 1.4. Internal Corner - Smaller Cladding Type

2. VERTICAL JOINTS

- 2.1. Vertical Joint Typical
- 2.2. Vertical Joint Orientation Change
- 2.3. Vertical Joint Smaller Cladding Type
- 2.4. Vertical Joint Larger Cladding Type

3. HORIZONTAL JOINTS

- 3.1. Typical Horizontal Joint
- 3.2. Interstorey Joint

4. CLADDING TOP & BOTTOM

- 4.1. Top of Cladding/Parapet
- 4.2. Bottom of Cladding at Ground
- 4.4. Bottom of Cladding at Apron Roof
- 4.8. Barge to Soffit

5. SOFFITS

- 5.1. Wall Below Soffit <90°
- 5.2. Wall Above Soffit <90°
- 5.6. Wall Below Flat Sheet Soffit <90°
- 5.8. Wall Below Flat Sheet Soffit >90°

7. JOINERY

- 7.1. Residential Window Jamb - Recessed
- 7.2. Residential Window Head - Recessed
- 7.3. Residential Window Sill - Recessed
- 7.4. Residential Window Jamb - WANZ/Supported
- 7.5. Residential Window Head - WANZ/Supported
- 7.6. Residential Window Sill - WANZ/Supported

Detail List

Detail Number

AC-H-AR-DL.2

Version

JAN 2024 [v1.4]

ALICLAD MAX

COMPLIANCE STATEMENT

AliClad Max System is an extruded aluminium cladding system that can be installed horizontally or vertically, comprised of 2.2mm thick interlocking weatherboards in multiple design profile options and an accompanying flashing system. The system has been designed up to extra high wind zone in accordance with NZS3604 and engineered to be fixed at increased span distances to provide simple, strong, and safe installations.

This compliance statement covers **AliClad Max System** on 20mm Drained & Ventilated cavities.

Allowance must be made for unhindered thermal expansion and contraction. AliClad Max System weatherboards must be cut to length allowing

a 1 mm gap per metre of board and the fixing holes must be oversized to accommodate potential movement.

NZBC Clause B1 Structure

B1.3.1, B1.3.2, B1.3.3(a,f,h,j,q), B1.3.4

AliClad Max System structural analysis was undertaken with capacities determined using and theoretical analysis. Span tables for 20mm cavities have been developed to determine the required cladding fixing, batten/rail fixing and screws to main structure fixing spacing.

The AliClad Max System cladding system has been designed to withstand up to

±2.40 kPa (ULS). When constructed in accordance with the structural and installation guidelines as per Appendix A, AliClad Max System will meet NZBC Clause B1.

NZBC Clause E2 External Moisture

E2.3.2, E2.3.5, E2.3.7

AliClad Max System is intended to be part of a rainscreen cladding system where the panels form the outermost water shedding layer. The cladding line is expected to deflect most of the water hitting the façade. The weather resistant line is located at the back of the rainscreen cavity that is typically constructed with a flexible building wrap or rigid air barrier compliant with NZBC E2/AS1: Table 23.

Where water does penetrate the cladding line, the cavity between the cladding and the structural wall is expected to prevent water being able to migrate onto the structural wall and allow water to drain down. The cavity also allows ventilation which aids in the drying of any residual water and drying of the structural wall.

NZBC C3 Fire Performance

C3.5, C3.6, C3.7a

AliClad Max System is manufactured from solid aluminium. As per MBIE Guidance (MBIE 2817 Fire Performance of External Wall Cladding Systems) that for buildings categorised as low risk (<10m high & >1m away from relevant boundary.) There are no requirements for fire testing protocols P1 to P5 and therefore all products are suitable for use in this application.

Where consideration of fire safety is required due to proximity of relevant boundaries, AliClad Max System can contribute to a building's performance when specified on one of the applicable non-combustible support systems available.

NZBC Clause B2 Durability

B2.3.1b, B2.3.2

AliClad Max System material is 6063-T5 grade aluminium and by its nature is inherently durable. Aluminium is a reactive metal that quickly forms a stable oxide layer upon contact with the atmosphere which seals the raw aluminium from further oxidation. Therefore, aluminium is fundamentally durable. Aluminium supports are suitable to be used in all New Zealand exposure/atmospheric zones.

In addition, the AliClad Max System is finished using premium powder coating systems, applied locally.

Timber and Plastic Battens and Fixings

On Low-Risk buildings where fire requirements allow, a timber or HDPE cavity packer batten system may be used. Where timber is used it must be at a minimum of H3.1 treatment. If applicable a suitable bond breaker must be utilised to ensure no contact between cladding, flashings, and treated battens. Fixings for AliClad Max System must achieve >35mm structural embedment into main structure.

Refer to Appendix A Fixing Table 1

Aluminium Battens and Fixings

Cladding rails and fixings are also manufactured from aluminium and stainless steel, both materials are recognised as sufficiently durable and should remain serviceable throughout the expected serviceability of the cladding system. Fixings of aluminium rails must achieve >45mm embedment into main structure.

Refer to Appendix A Fixing Tables 2 & 4

Galvanised Support and Battens

To meet the durability requirements, mild steel support and battens need to be protected against corrosion. Support frames must have a minimum wall thickness of 1.15BMT. Support frames are to be coated with Zinalume steel AZ150. The Building Agency only specify Zinalume coatings for buildings with Exposure Zone of B and C to achieve the durability requirement specified in NZBC Clause B2. In addition, as outlined on NZBC E2/AS1 Table 20, hidden elements coated with AZ150 can achieve 50-year durability. Fixings of galvanised support battens rails must achieve >35mm embedment into main structure.

Refer to Appendix A Fixing Tables 3 & 5

Design Responsibility

It is expected that the architect/specifier's design intent and specifications (including specified materials, & compatibility where items are subject to material run-off affecting durability) where applicable have been reviewed against the New Zealand Building Code. AliClad Max System, when correctly specified will comply to or contribute to compliance to the following NZBC Clauses and their listed performance clauses as listed.



MATERIALS • SYSTEMS • SOLUTIONS

APPENDIX A - SPAN TABLES

Table 1: Horizontally Aligned - Installed on Timber or Plastic Batten

WIND ZONE	ALICLAD TYPE				
	V136	V200	S150	S200	S125/75
	MAXIMUM ALLOWABLE SPAN (mm)				
LOW 00m/s-32m/s <0.6kPa	2200	2200	2200	2200	2200
MEDIUM 32m/s-37m/s >0.66kPa & <0.88kPa	2000	2000	2000	2000	2000
HIGH 37m/s-44m/s >0.88kPa & <1.25kPa	1800	1800	1800	1800	1800
VERY HIGH 44m/s-50m/s >1.25kPa & <1.61kPa	1600	1600	1600	1600	1600
EXTRA HIGH 50m/s-55m/s >1.61kPa & <1.9kPa	1400	1400	1400	1400	1400
SPECIFIC ENGINEERING DESIGN >55m/s >1.9kPa	SED	SED	SED	SED	SED

1. SS304 12g x 65mm HexTek Screw 10mm Hex (35mm minimum embedment), screw fixing at every AliClad board.
 2. Table is applicable for non-structural H3.1 Timber and Extruded Plastic cavity packer battens either of which form a nominal 20mm cavity
 3. Wind Zone Classifications - ULS From NZS3604, considered in Positive(+) Pressure and Negative(-) Suction

** Design Assumptions:*

- The wind pressures are for external wind only. Internal pressures will not be applied to the cladding and assumed to be resisted by the internal lining.
- Load on each panel is uniformly distributed.
- The span/deflection limit for SLS wind load is 250mm for aluminium battens/zincalume top hats and L/175 for the AliClad boards, with the serviceability wind load equal to 68% of the ULS wind load.
- SS304 12g x 65mm HexTek SD Screw 10mm Hex (AliClad board to Timber Batten)
- Timber is assumed Radiata Pine (Group J4 for withdrawal, group 5 in shear, with a characteristic density in excess of 420kg/m³).
 - Timber studs at 600mm o/c and
 - timber nogs/dwangs at 800mm o/c and
- For Edge Distances Framing fixing face thickness is assumed as 45mm

Selected Building Flexible Membrane/RAB/RWU must be compliant to E2:Table 23

Fixings for Horizontal Timber Batten @ Each Nog = 800mm MAX C/C or less as appropriate to site wind zone & bracing requirements in accordance with NZS3604

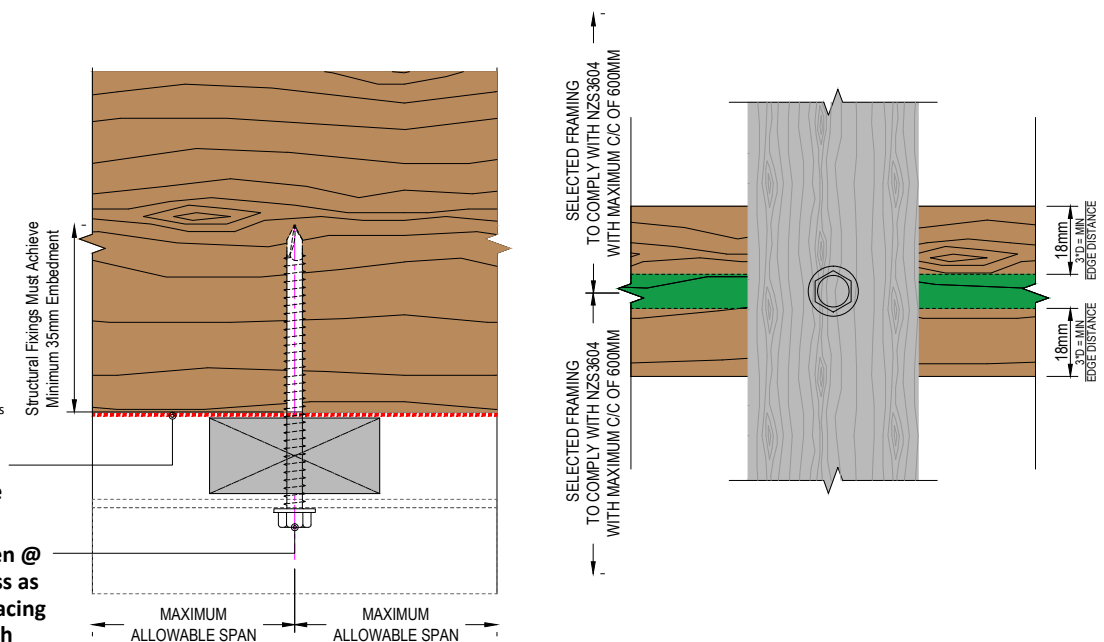

ALICLAD MAX

PARTS LIST

CLADDING PROFILES

- ACV136** - AliClad Max V136, 136x25 V Shiplap Weatherboard, 5.8m.
ACV200 - AliClad Max V200, 200x25 V Shiplap Weatherboard, 5.8m.
ACS150 - AliClad Max S150, 150x25 Shadow Groove Weatherboard, 5.8m.
ACS200 - AliClad Max S200, 200x25 Shadow Groove Weatherboard, 5.8m.
ACS125/75 - AliClad Max S200-125/75, 200x25 Shadow Groove Weatherboard with 75mm & 125mm board look, 5.8m.

2 PIECE BASE CLIPS

- ACHMDB-58** AliClad Max - H Mould Base, 5.8m.
ACJMDB-58 AliClad Max - J-Mould Base, 5.8m.
ACJMDF-58 AliClad Max - J-Mould Face, 5.8m, Selected Finish.
ACINTB-58 AliClad Max - Internal Corner Base, 5.8m, Selected Finish.
ACEXTB-58 AliClad Max - External Corner Base, 5.8m.
ACJMDBC-58 AliClad Max - Bottom of Cladding Base, 5.8m, Selected Finish.

2 PIECE FACES & TRIMS

- ACINTF** - AliClad Max - Internal Corner Face, 5.8m.
ACWNS - AliClad Max - Window Sill Face, - to suit WANZ supported window, 5.8m, Selected Finish.
ACWNSP - AliClad Max - Window Sill Face - to suit Punched Window, 5.8m, Selected Finish.
ACJMDF - AliClad Max - J Mould Face, 5.8m, Selected Finish.
ACHMDF - AliClad Max - H Mould Face, 5.8m, Selected Finish.
ACEXTF - AliClad Max - External Corner Face, 5.8m, Selected Finish.

JUNCTION ELEMENTS

- ACCLZ-58** AliClad Max - Clamp Zed, 5.8m, Selected Finish.
ACCLC-58 AliClad Max - Clamp Channel, 5.8m, Mill Finish.
ACSTR-58 AliClad Max - Starter Rail, 5.8m, Mill Finish.
ACJMC-58 AliClad Max - Jamb Clip, 5.8m, Mill Finish.
ACJMF-58 AliClad Max - Jamb Flashing, 5.8m, Selected Finish.

MECHANICAL DRAINAGE SYSTEM

- ACJMT-01RIGHT** AliClad Max - Type 1a Jamb Tray Right
ACJMT-01LEFT AliClad Max - Type 1b Jamb Tray Left
ACJMT-02RIGHT AliClad Max - Type 2a Jamb Tray Right
ACJMT-02LEFT AliClad Max - Type 2b Jamb Tray Left

ALPHA RAIL SUPPORT SYSTEM PROFILES

- AR-CLIP100** Alpha Rail Packer Clip 10mm, 50mm.
AR-CLIP50 Alpha Rail Packer Clip 5mm, 50mm.
AR-CLIP30 Alpha Rail Packer Clip 3mm, 50mm.
AR-CLIP16 Alpha Rail Packer Clip 1.6mm, 50mm.
AR-RAIL20H Alpha Rail Vertical Rail 20mm, 5.8m.
AR-RAIL20V Alpha Rail Horizontal Rail 20mm, Drained, 5.8m.

AliClad Max - Parts List

Detail Number

AC-Part List

Version

[V2.2]



MATERIALS • SYSTEMS • SOLUTIONS

ALICLAD MAX

CLADDING PROFILES

HIGH PERFORMANCE ALUMINIUM
WEATHERBOARD SYSTEM

2.1

VI36

V200

SI50

S200

SI25-75

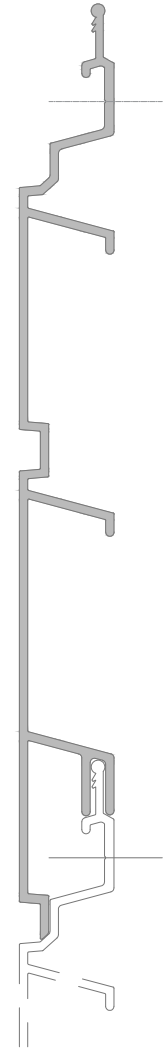
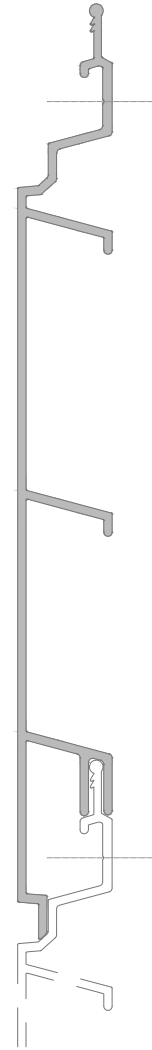
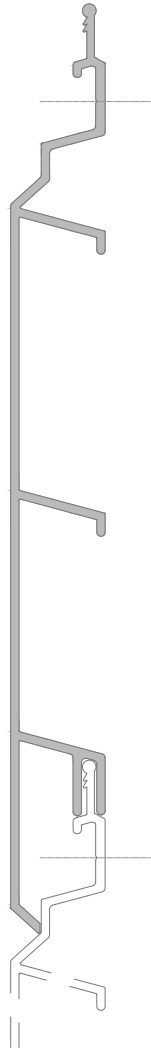
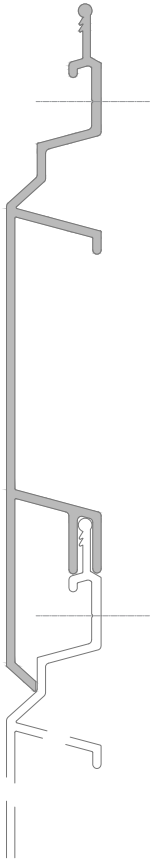

V - GROOVE



S - SQUARE - GROOVE

Extruded Profiles - Cladding

Detail Number

AC-H-TB-PRO-01

Version

[V2.2]



MATERIALS • SYSTEMS • SOLUTIONS

ALICLAD MAX

TRIMS - PROFILES

TYPICAL ASSEMBLIES

J-MOULD

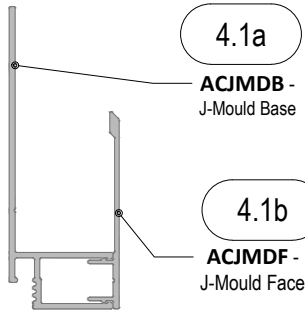

WANZ WINDOW SILL

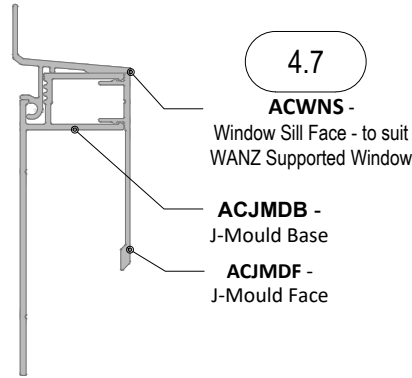

PUNCHED WINDOW SILL

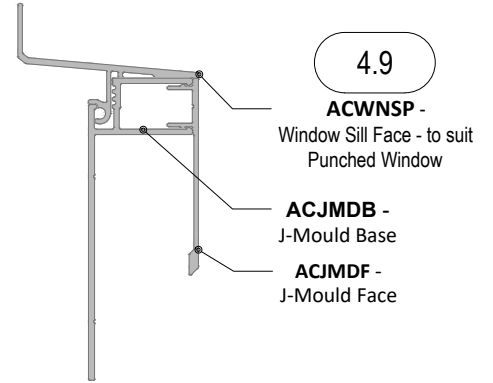

TYPICAL BASE OF CLADDING

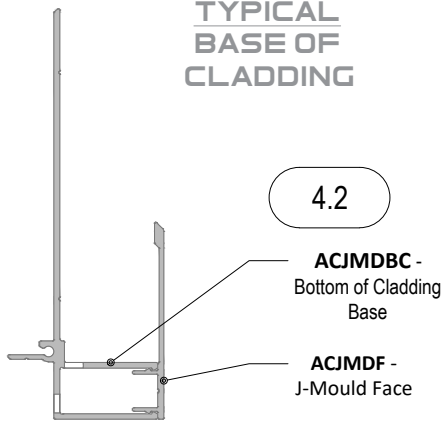

TYPICAL JAMB

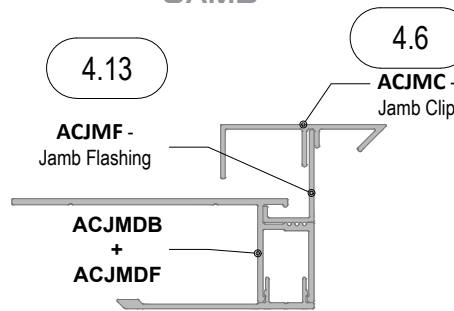

STARTER

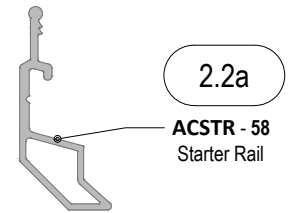

ENDER

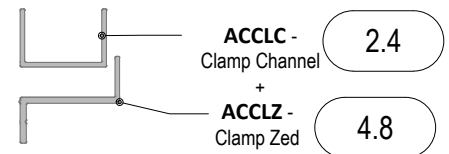

TYPICAL VERTICAL H-JOINT

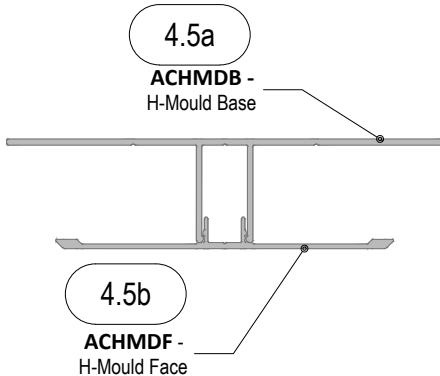

EXTERNAL CORNER

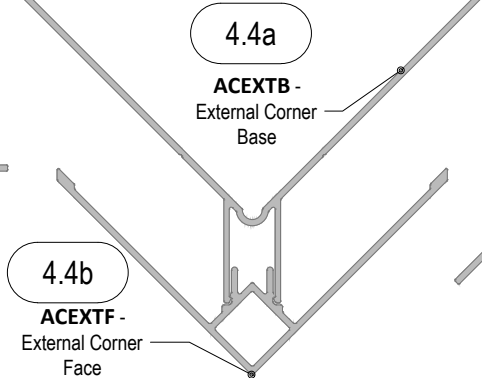

INTERNAL CORNER

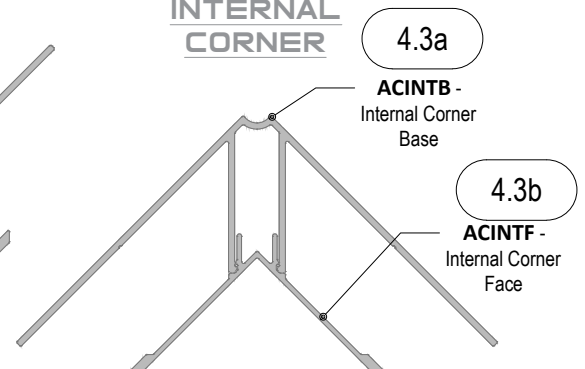

Detail Number

AC-H-TB-PRO-2

Version

[V2.2]

Extruded Profiles - Trims



MATERIALS • SYSTEMS • SOLUTIONS

ALICLAD MAX

MECHANICAL DRAINAGE SYSTEM

PROPRIETARY JAMB-TO-SILL DRAINAGE CLIPS
- AVAILABLE IN WHITE, GREY AND BLACK.

TYPE I - FOR WINDOWS USING WANZ BAR SUPPORT

ACJMT-01LEFT -
Type 1 Jamb Tray Left

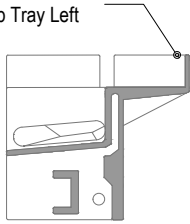

SECTION

4.11a

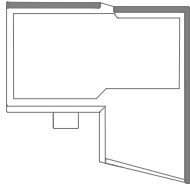

PLAN

ACJMT-01RIGHT -
Type 1 Jamb Tray Right

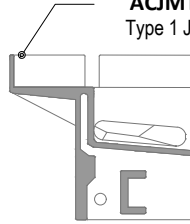

4.11b

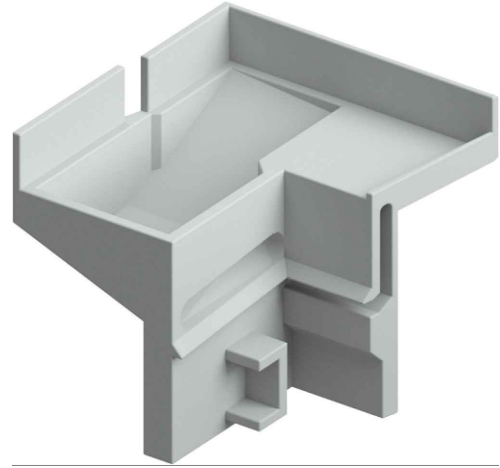
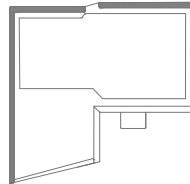

TYPE II - FOR PUNCHED OR RECESSED WINDOWS

ACJMT-02LEFT -
Type 2 Jamb Tray Left

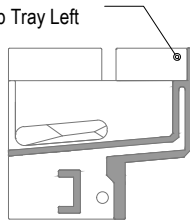

SECTION

4.12b

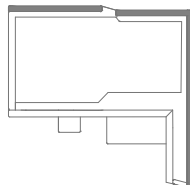

PLAN

ACJMT-02RIGHT -
Type 2 Jamb Tray Right

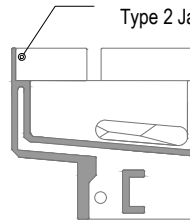

4.12a

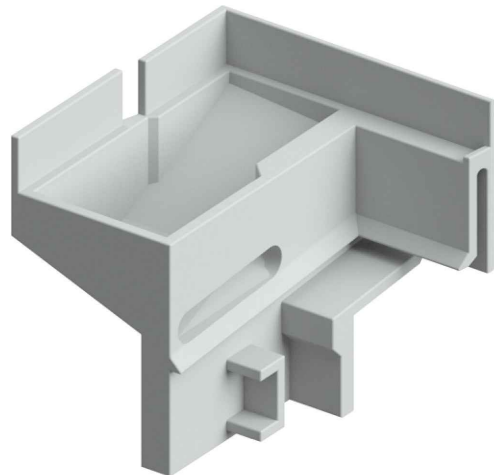
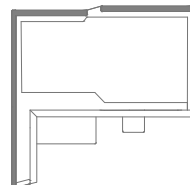

Mechanical Drainage System

Detail Number

AC-MDS-1

Version

[V2.2]



MATERIALS • SYSTEMS • SOLUTIONS

VENTILATED CAVITY H3.1 TIMBER BATTENS

ALL HORIZONTALS
45X20MM DUAL BEVEL/DUAL CASTELLATION



Top View

3.1

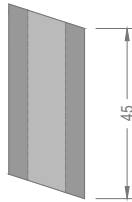

Side View

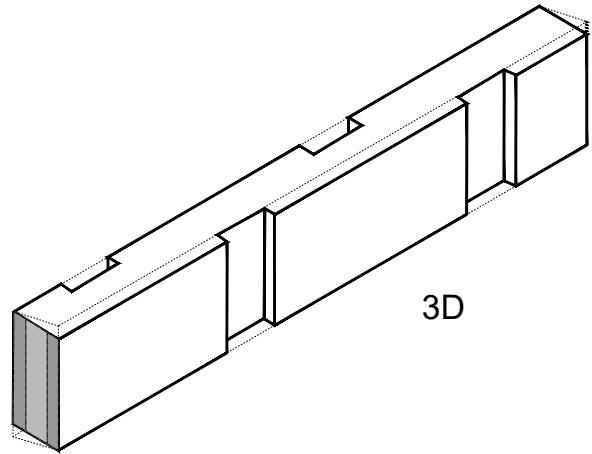

3D

ALL VERTICALS
45X20MM SQUARE

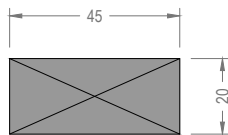

3.2

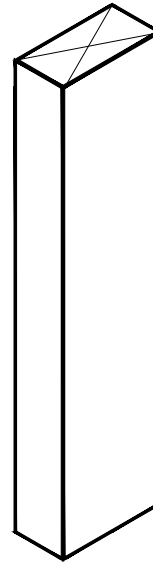

3D

Timber Cavity Batten System

Detail Number

ARS-ACC-01

Version

[V2.1]

ALICLAD MAX

PROCESSING - RIPPED WEATHERBOARD TERMINATION

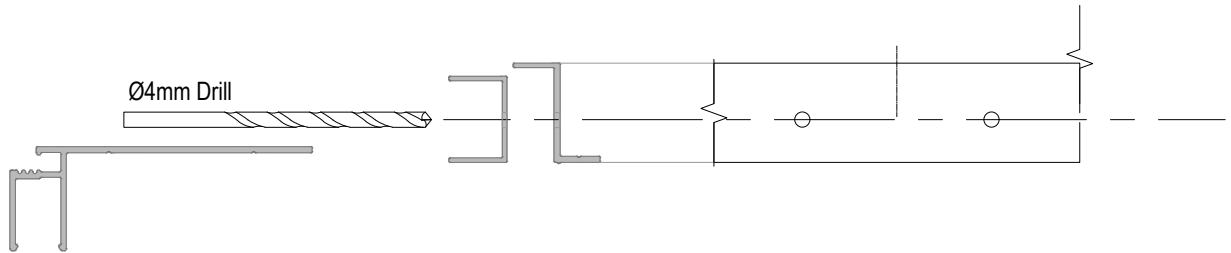
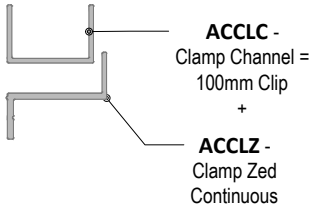

Common location for
termination assembly :
Into J-Moulds or Corner
moulds

ACCLC - Clamp Channel 100mm
Clips Fixed with 2x No4-4 Pop
Rivets to continuous **ACCLZ** at
800mm MAXIMUM centres &
100mm MAX from Ends

**Ripped Board Edge Goes
Here**



General Processing

Detail Number

AC-GP-1

Version

[V2.2]



MATERIALS • SYSTEMS • SOLUTIONS

ALICLAD MAX

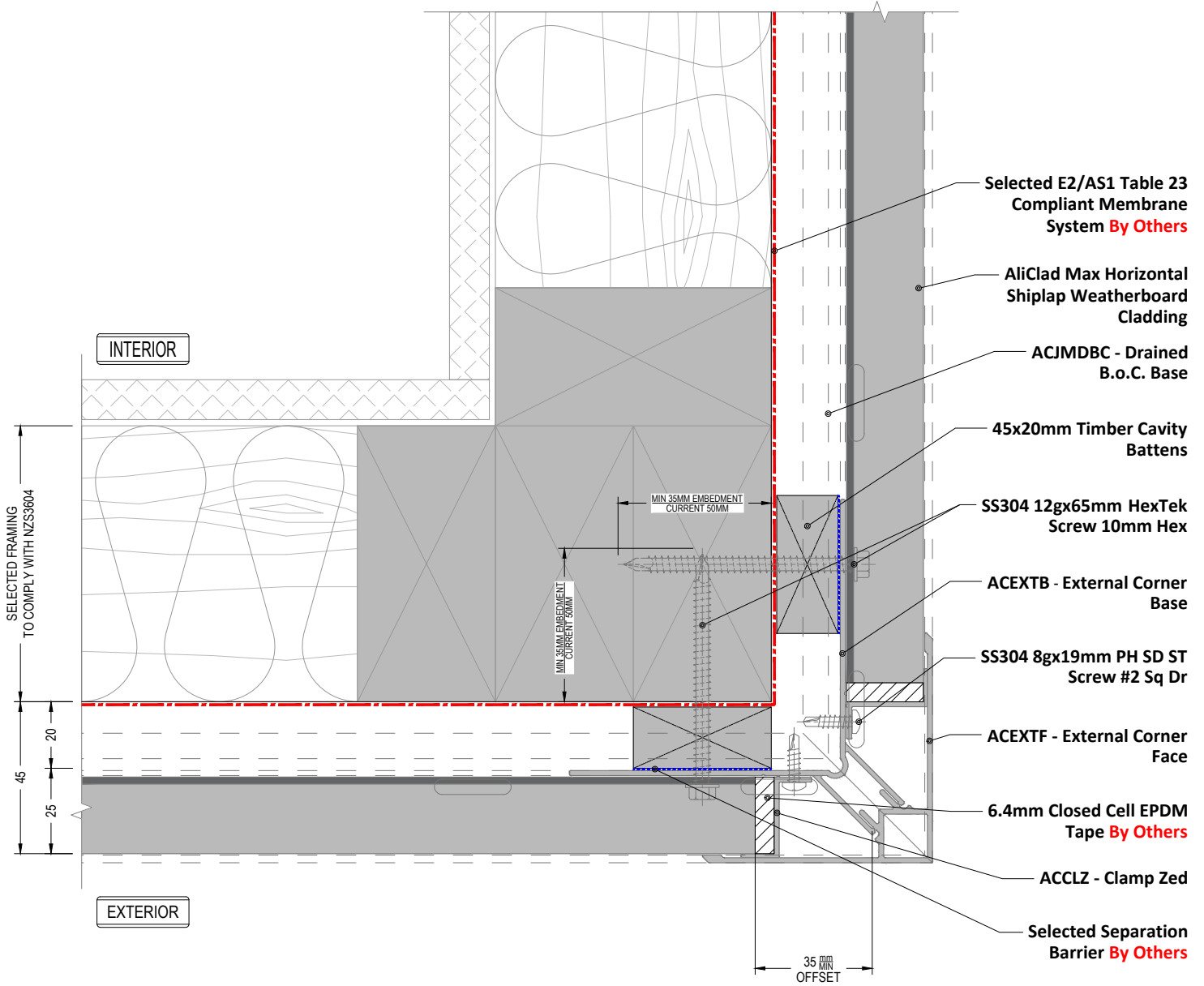

NOTE
ACJMDBC - Drained B.O.C. Base Shown in dashed lines

External Corner

Detail Number
AC-H-TB-1.1

Version
[V2.2]



MATERIALS • SYSTEMS • SOLUTIONS

ALICLAD MAX

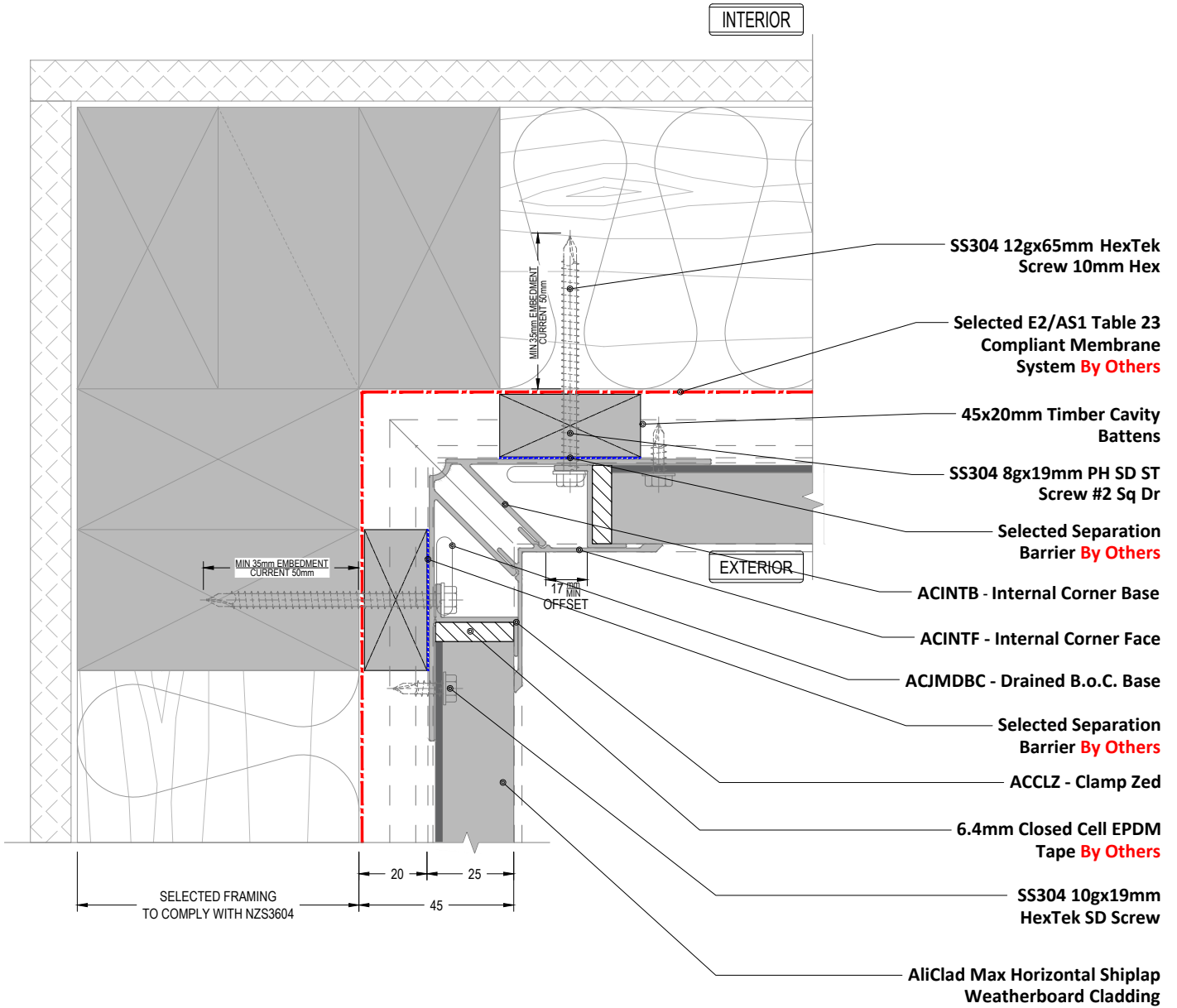

NOTE
ACJMDBC - Drained B.O.C. Base Shown in dashed lines

Internal Corner

Detail Number
AC-H-TB-1.2
Version
[V2.2]



MATERIALS • SYSTEMS • SOLUTIONS

ALICLAD MAX

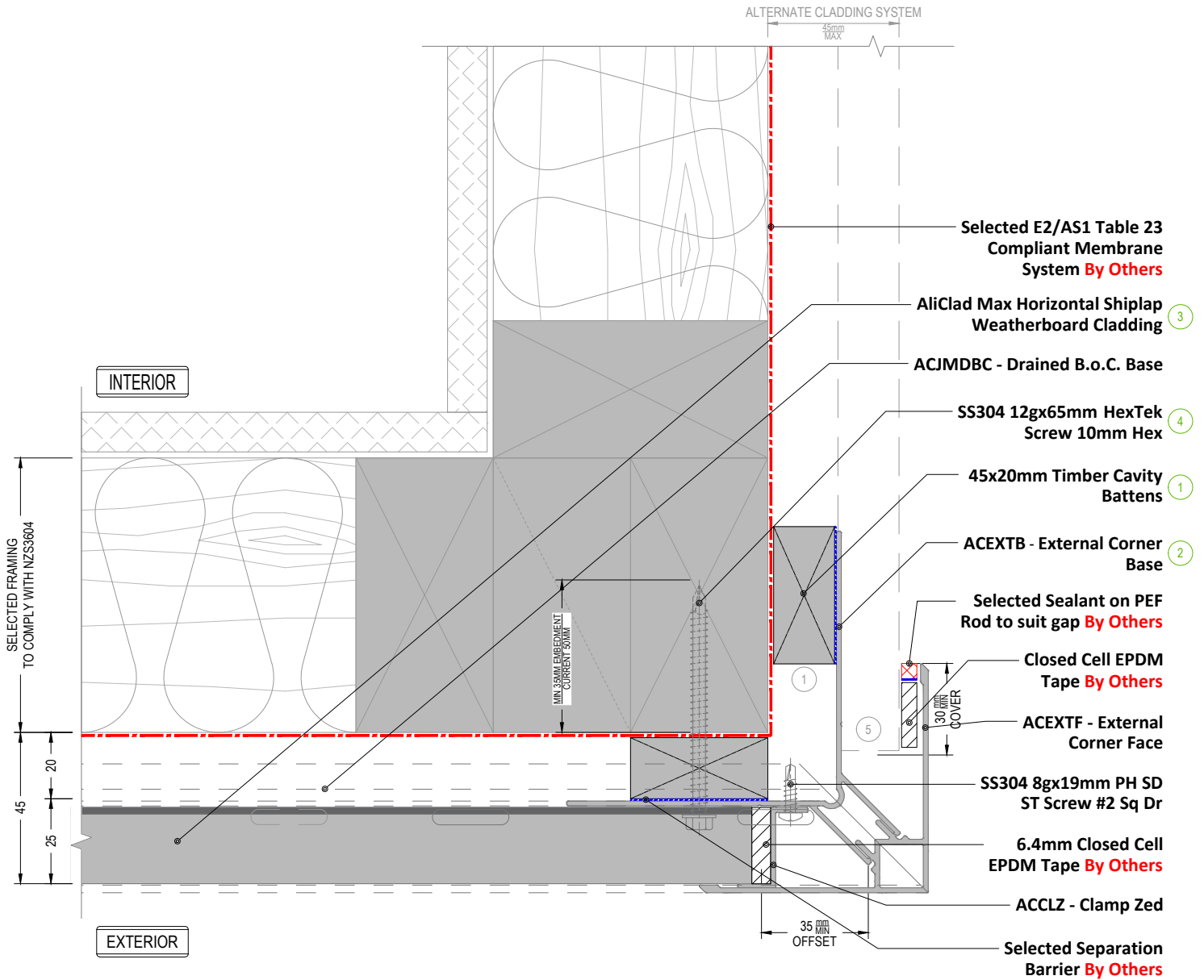

NOTE
ACJMDBC - Drained B.O.C. Base Shown in dashed lines

SEQUENCE OF INSTALLATION	
1	45x20mm Timber Cavity Battens
2	External Corner Base
3	AliClad Max Horizontal Shiplap Weatherboard Cladding
4	SS304 12x65mm HexTek Screw
5	Alternate Cladding Exterior

Ext Cnr_SML Cladding Type

Detail Number
AC-H-TB-1.3

Version
[V2.2]



MATERIALS • SYSTEMS • SOLUTIONS

ALICLAD MAX

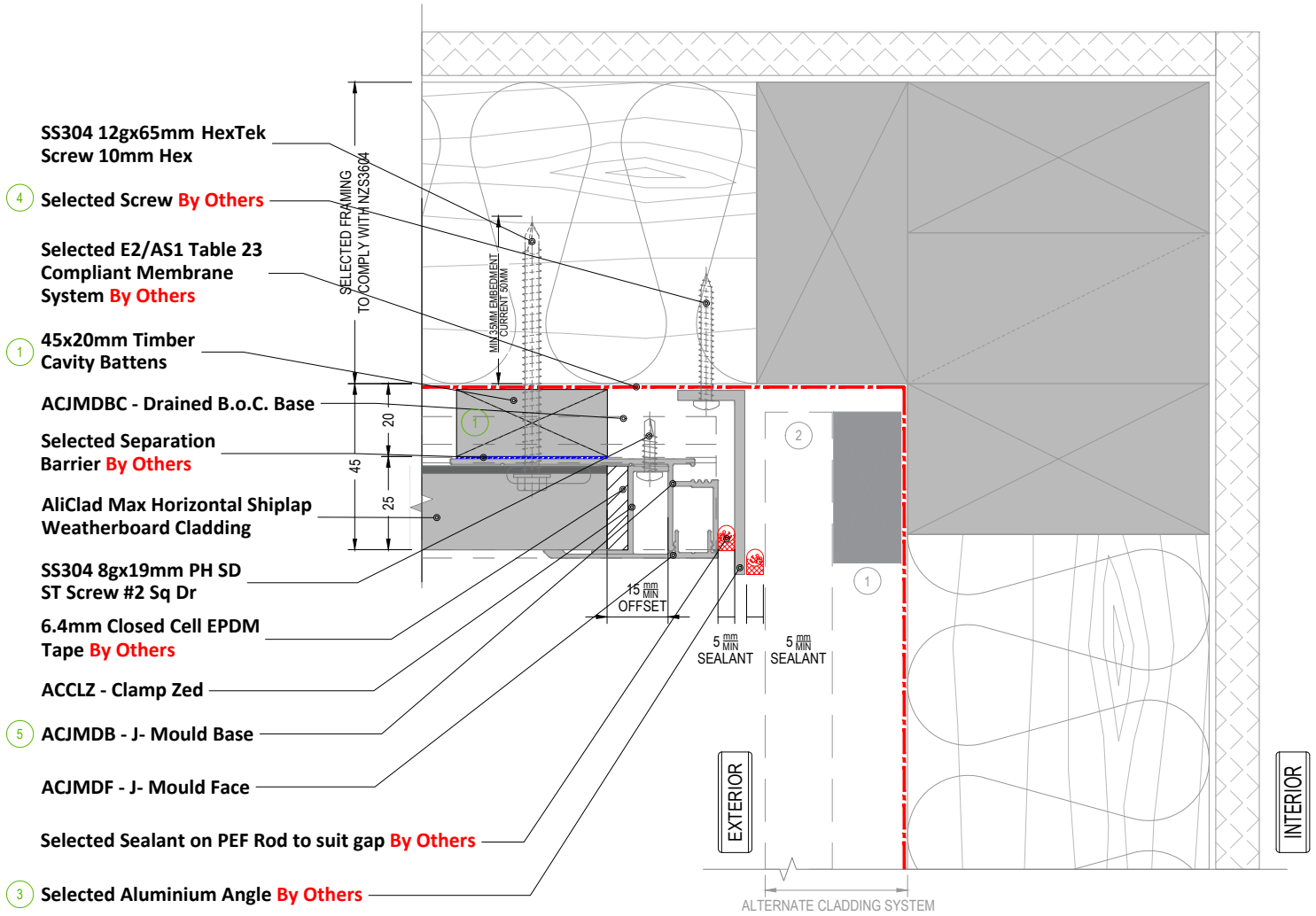

NOTE 1
ACJMDBC - Drained B.O.C. Base Shown in dashed lines

NOTE 2
Flashings and Angles are not included in the system

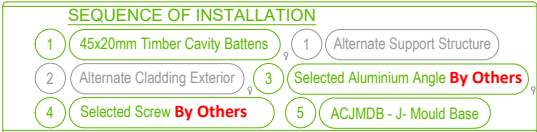

Int Cnr_SML Cladding Type

Detail Number
AC-H-TB-1.4

Version
[V2.2]



MATERIALS • SYSTEMS • SOLUTIONS

ALICLAD MAX

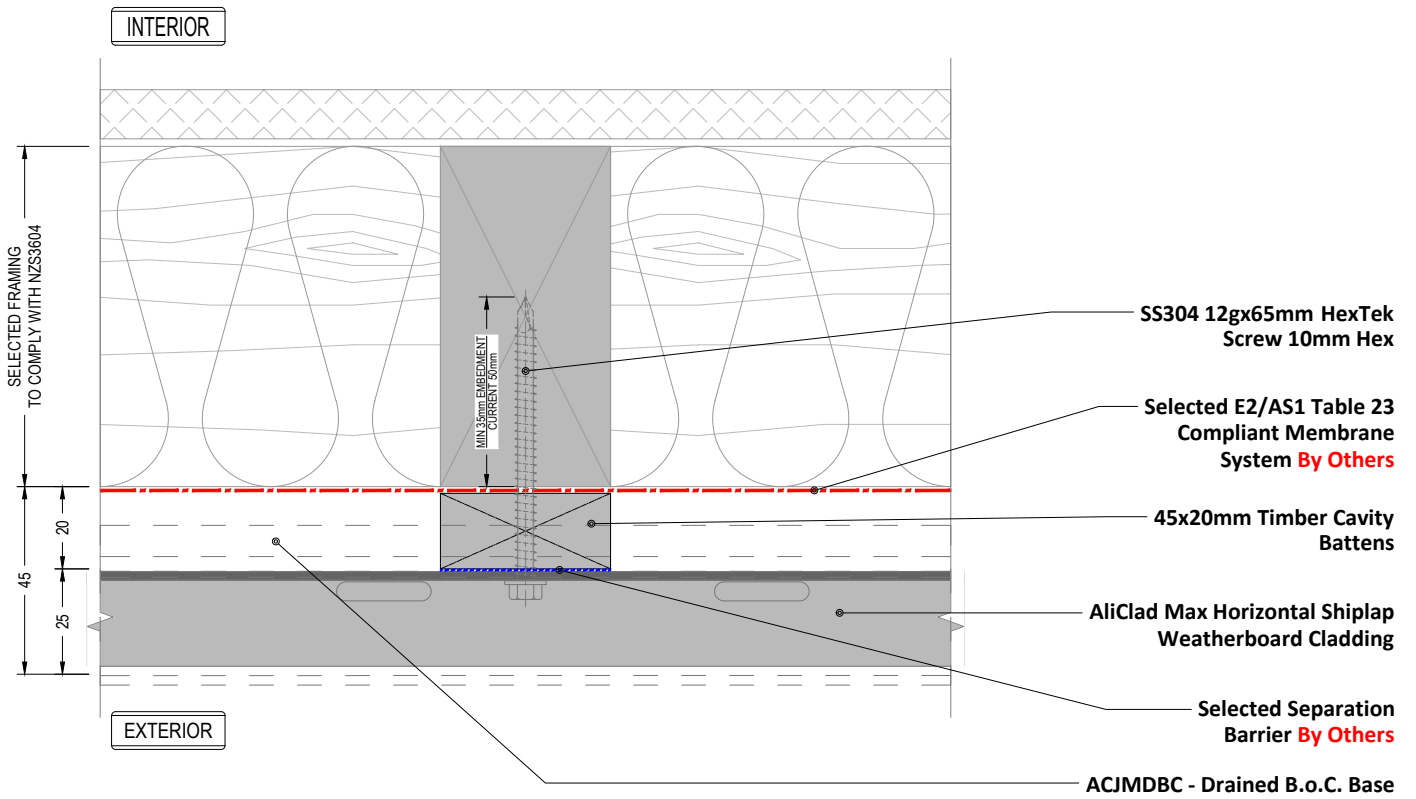

Vertical Joint - Typical

Detail Number

AC-H-TB-2.1

Version

[V2.2]



MATERIALS • SYSTEMS • SOLUTIONS

ALICLAD MAX

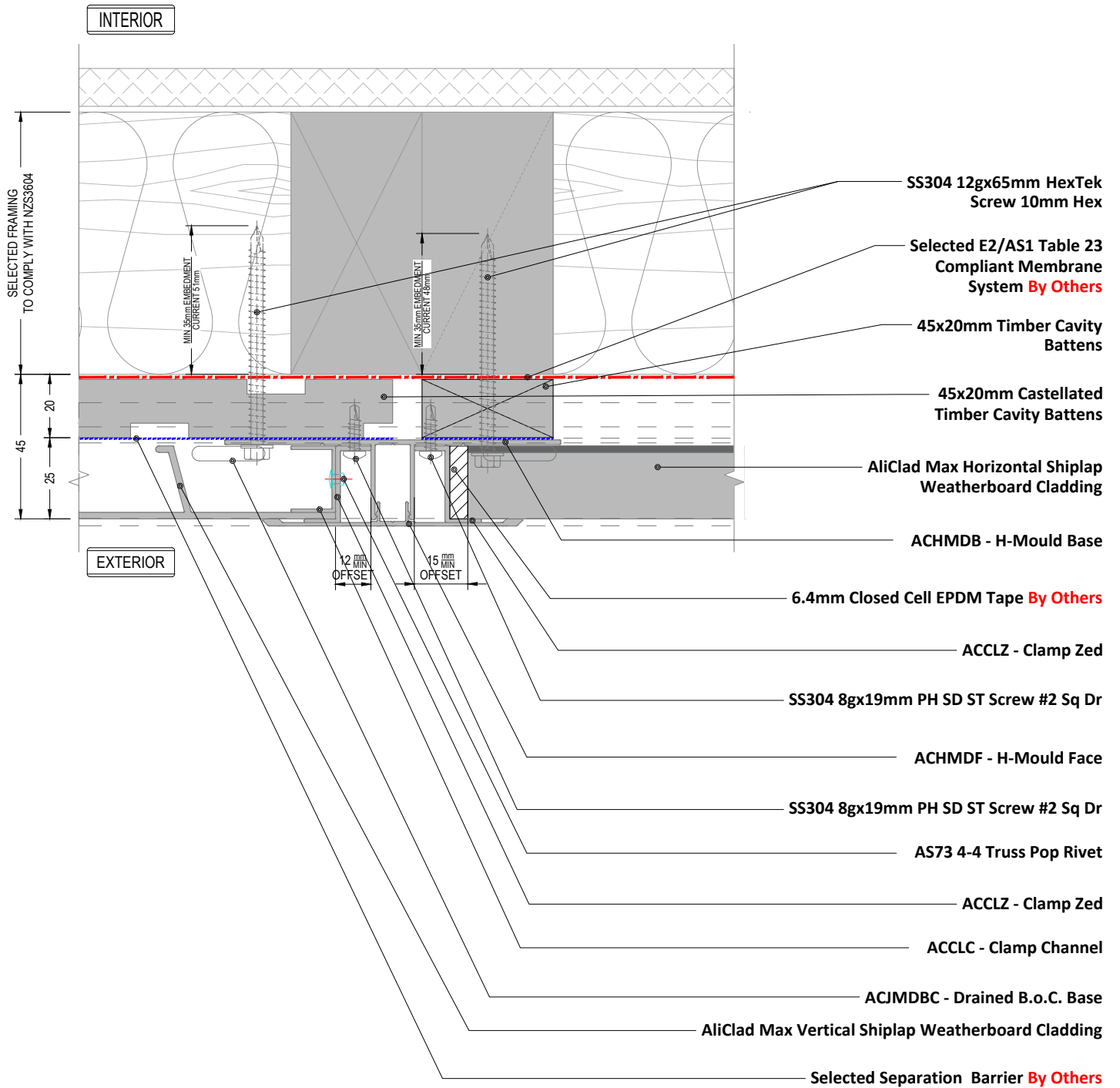

NOTE 1
ACJMDBC - Drained B.O.C. Base Shown in dashed lines
NOTE 2
Additional Framing is required at junction of
cladding types to ensure adequate fixing

Vert. Joint_Orientation Change

Detail Number
AC-H-TB-2.2
Version
[V2.2]



MATERIALS • SYSTEMS • SOLUTIONS

ALICLAD MAX

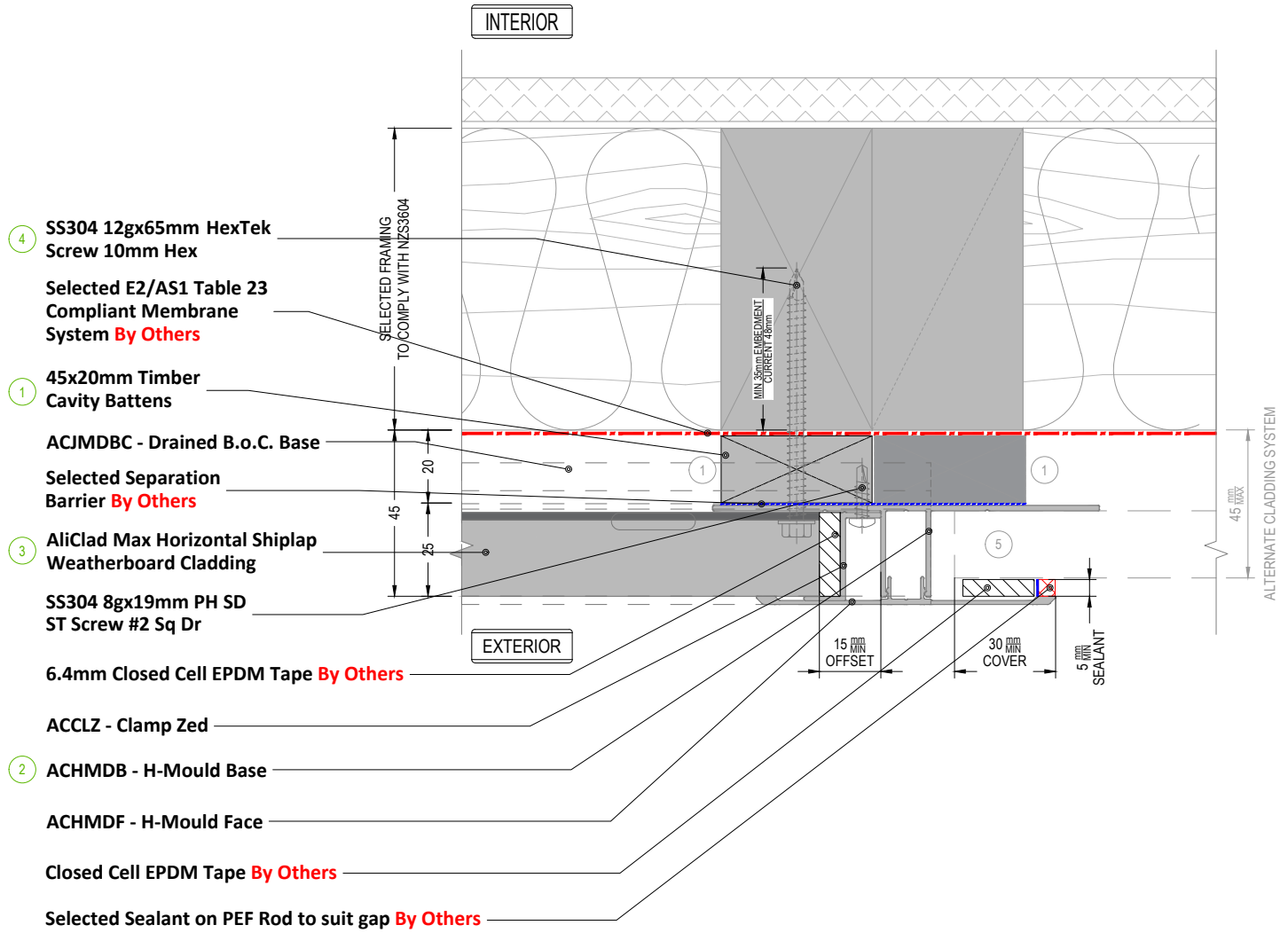

NOTE 1
ACJMDBC - Drained B.O.C. Base Shown in dashed lines
NOTE 2
Additional Framing is required at junction of cladding types to ensure adequate fixing

SEQUENCE OF INSTALLATION				
1	45x20mm Timber Cavity Battens	1	Alternate Support Structure	
2	ACHMDB - H-Mould Base	3	AliClad Max Horizontal Shiplap Weatherboard Cladding	
4	SS304 12gx65mm HexTek Screw	5	Alternate Cladding Exterior	

Vert. Joint_SML Cladding Type

Detail Number _____
AC-H-TB-2.3
Version _____
[V2.2]



MATERIALS • SYSTEMS • SOLUTIONS

ALICLAD MAX

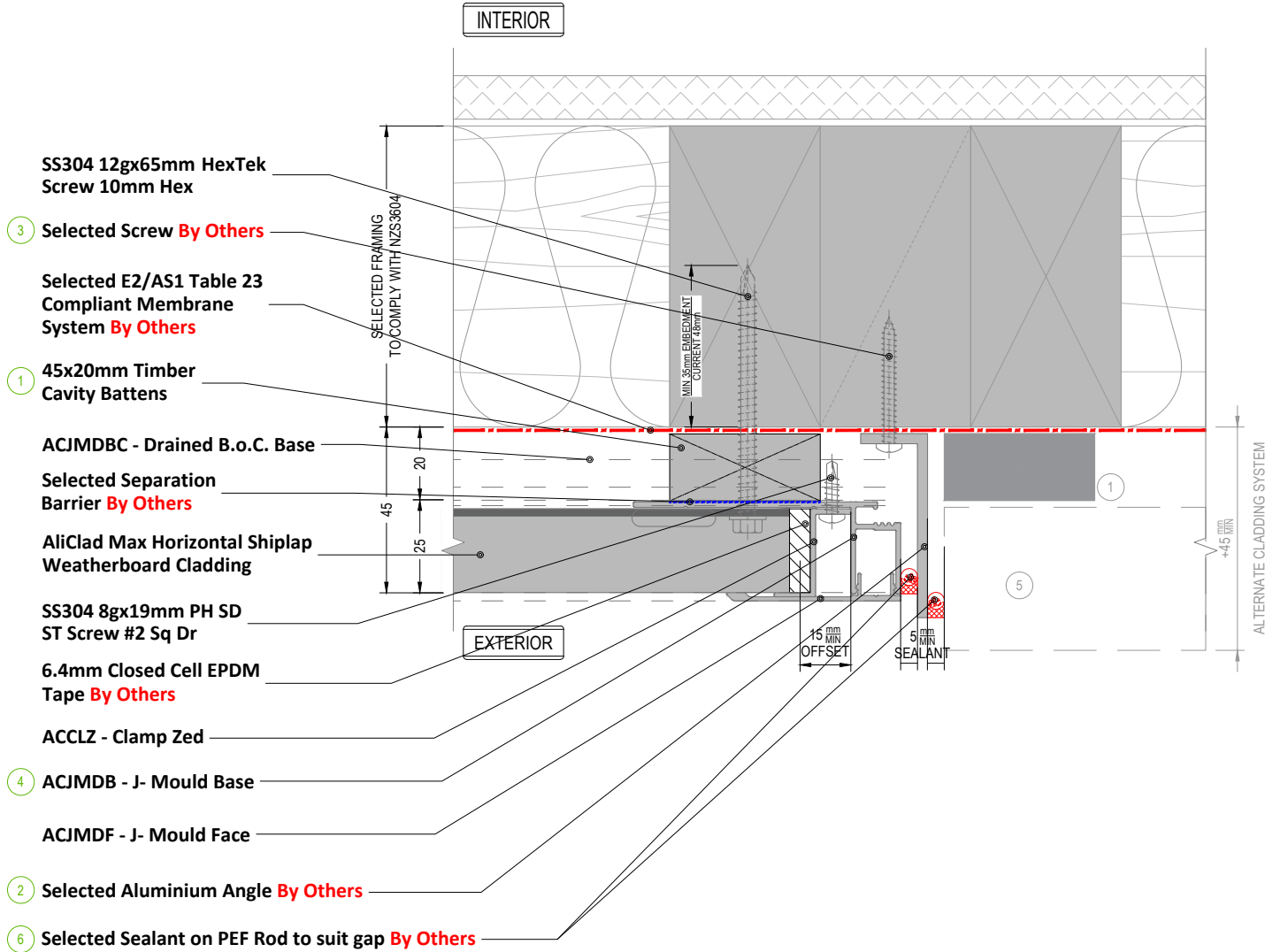

NOTE 1
ACJMDBC - Drained B.O.C. Base Shown in dashed lines

NOTE 2
Additional Framing is required at junction of cladding types to ensure adequate fixing

NOTE 3
Flashings and Angles are not included in the system



Vert. Joint_LRG Cladding Type

Detail Number
AC-H-TB-2.4

Version
[V2.2]



MATERIALS • SYSTEMS • SOLUTIONS

ALICLAD MAX

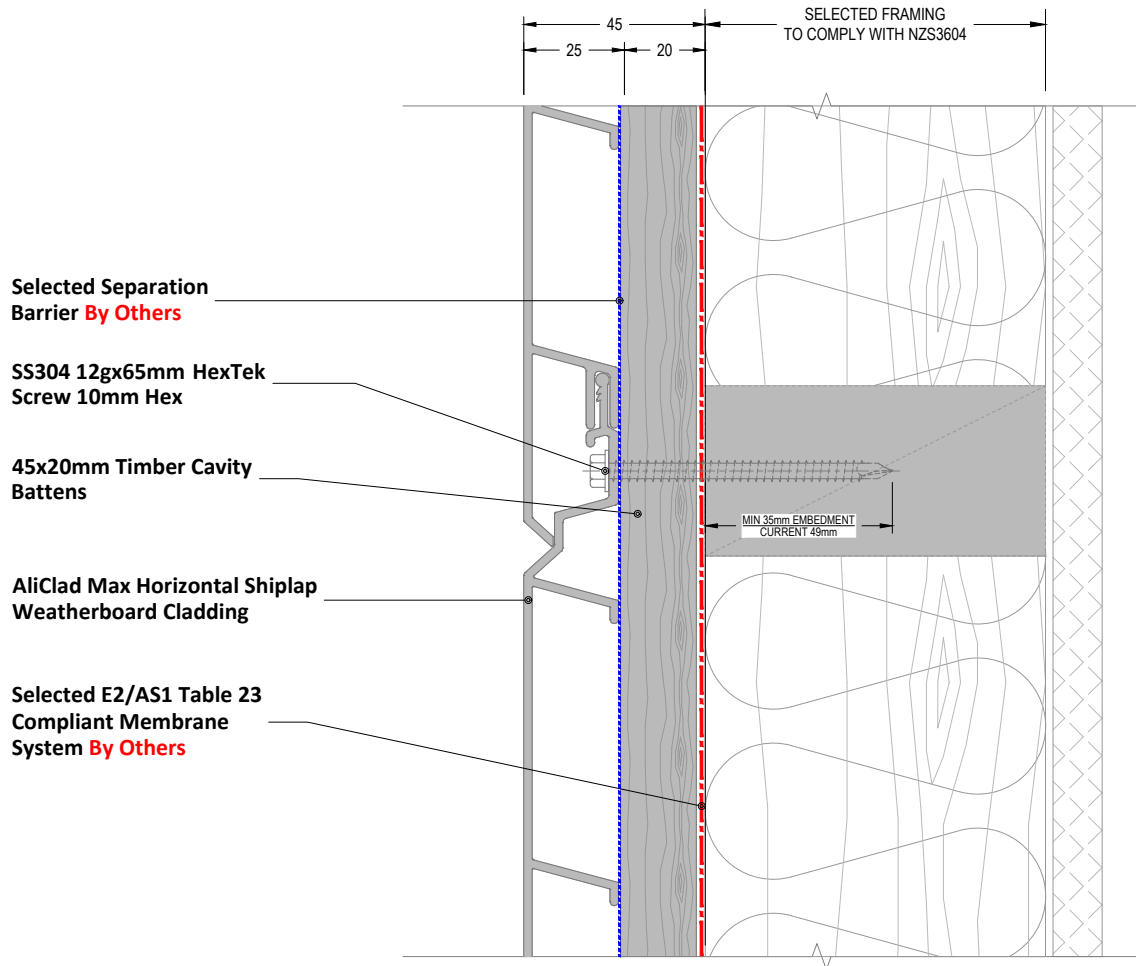

Hori. Joint_Typical

Detail Number
AC-H-TB-3.1

Version
[V2.2]



MATERIALS • SYSTEMS • SOLUTIONS

ALICLAD MAX

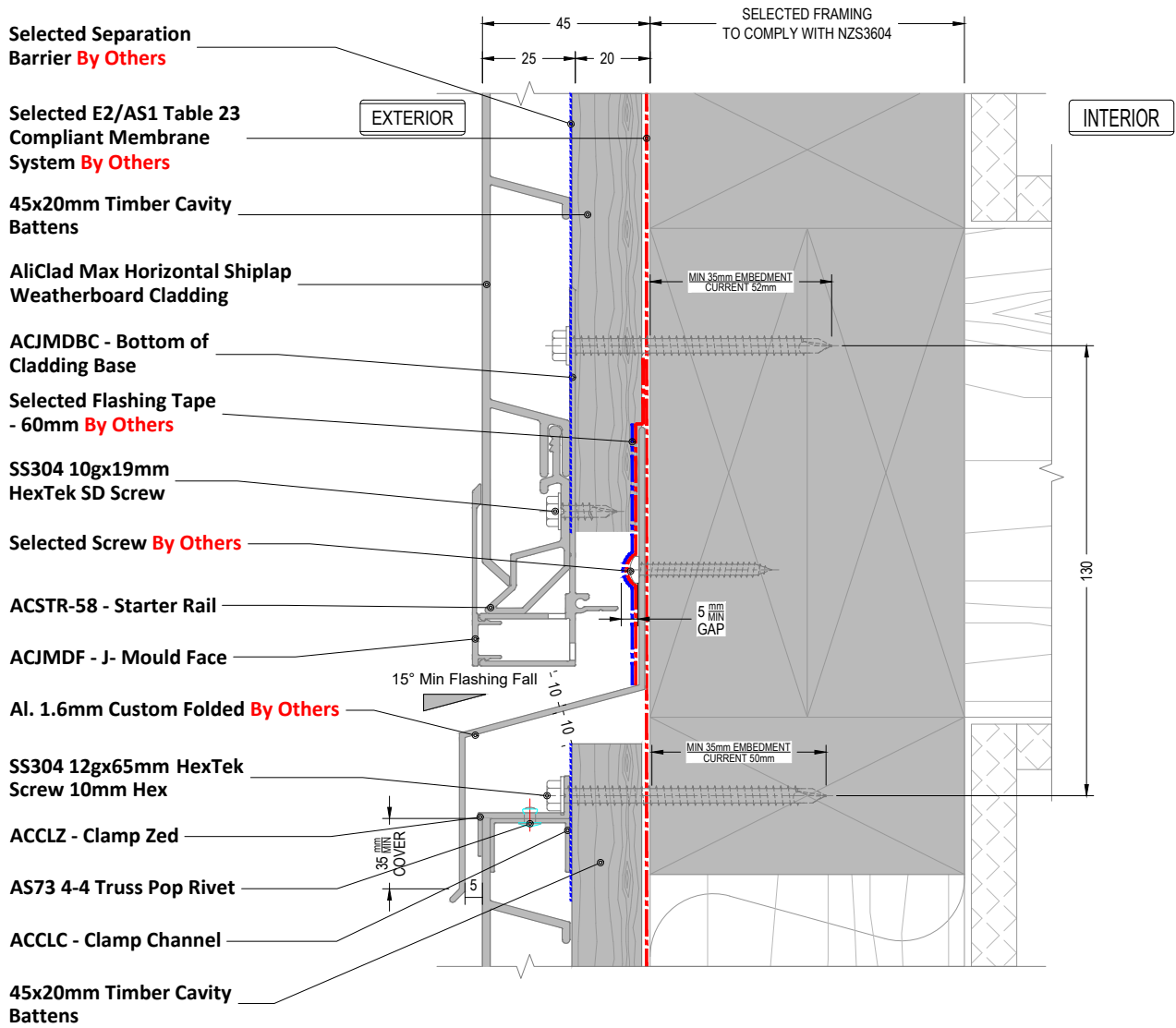

NOTE
Flashings and Angles are not included in the system

Interstorey Joint

Detail Number
AC-H-TB-3.2

Version
[V2.2]



MATERIALS • SYSTEMS • SOLUTIONS

ALICLAD MAX

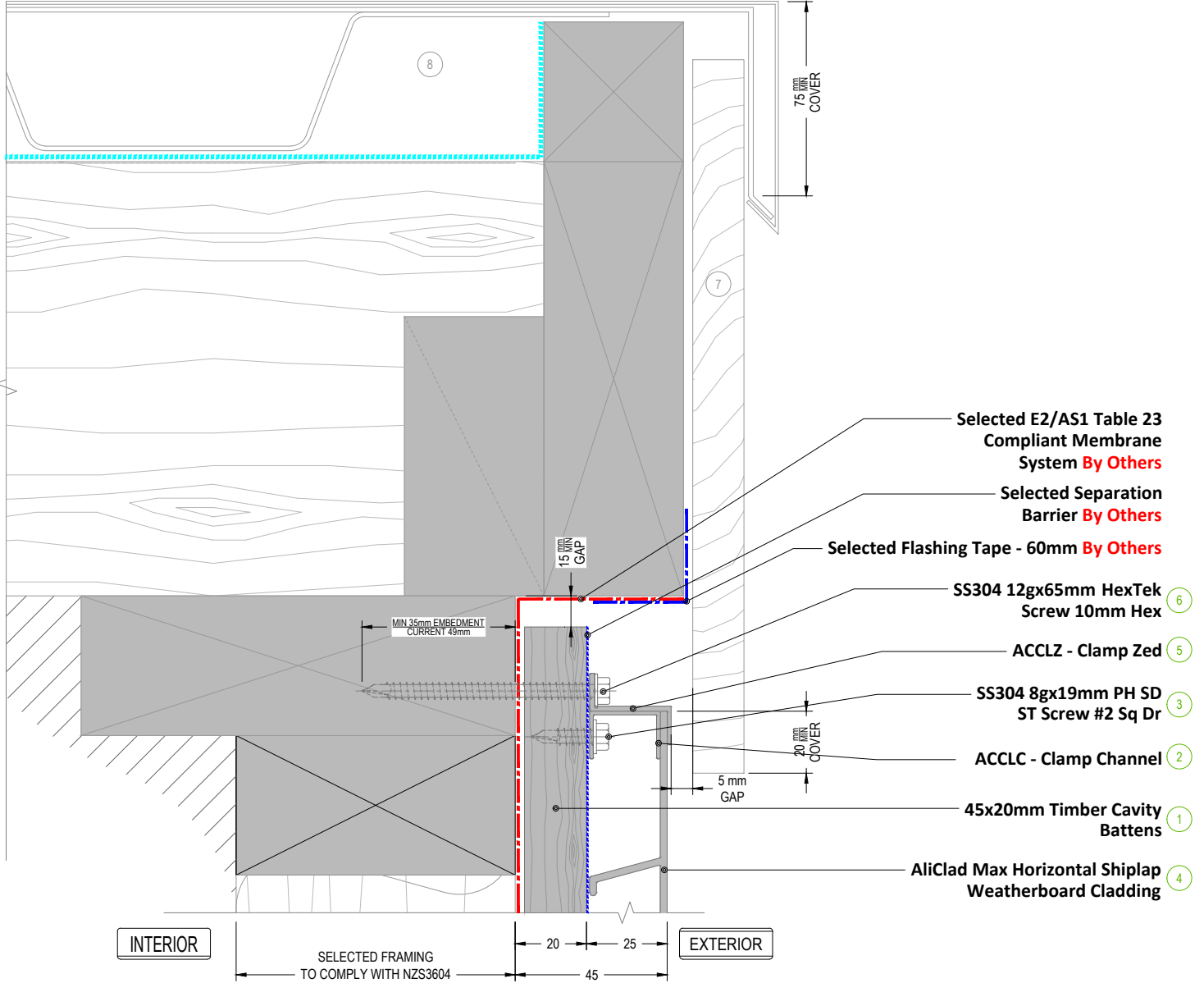

SEQUENCE OF INSTALLATION

- | | | | |
|---|-------------------------------|---|------------------------------------------------------|
| 1 | 45x20mm Timber Cavity Battens | 2 | ACCLC - Clamp Channel |
| 3 | SS304 8gx19mm PH SD ST Screw | 4 | AliClad Max Horizontal Shiplap Weatherboard Cladding |
| 5 | ACCLZ - Clamp Zed | 6 | SS304 12gx65mm HexTek Screw |
| 7 | Barge Board | 8 | Roof System |

Detail Number

AC-H-TB-4.1

Version

[V2.2]

TOP Cladding_Parapet



MATERIALS • SYSTEMS • SOLUTIONS

ALICLAD MAX

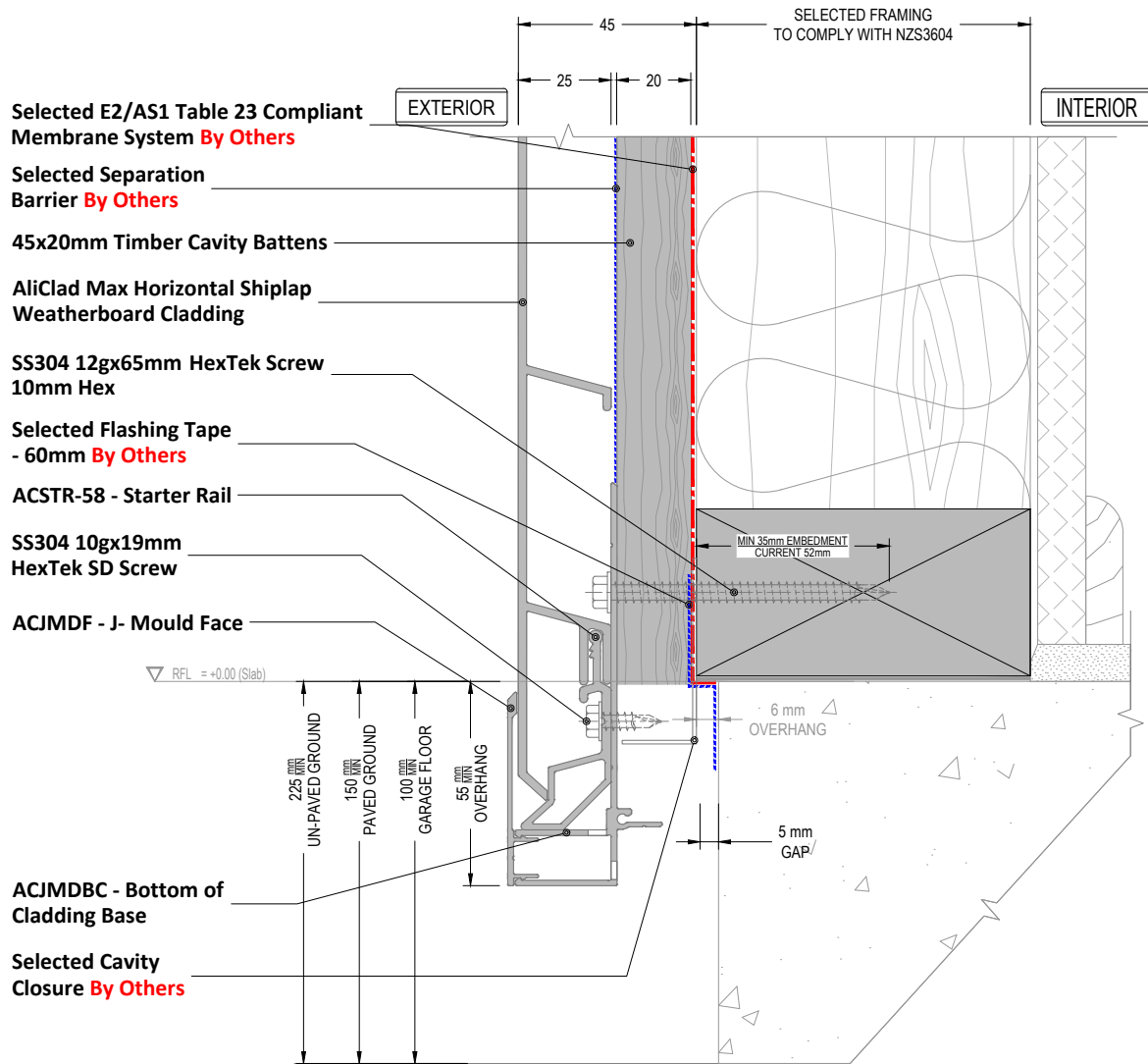

NOTE

Cavity Closure are not included in the system

Detail Number

AC-H-TB-4.2

Version

[V2.2]

BTM Cladding_G.L



MATERIALS • SYSTEMS • SOLUTIONS

ALICLAD MAX

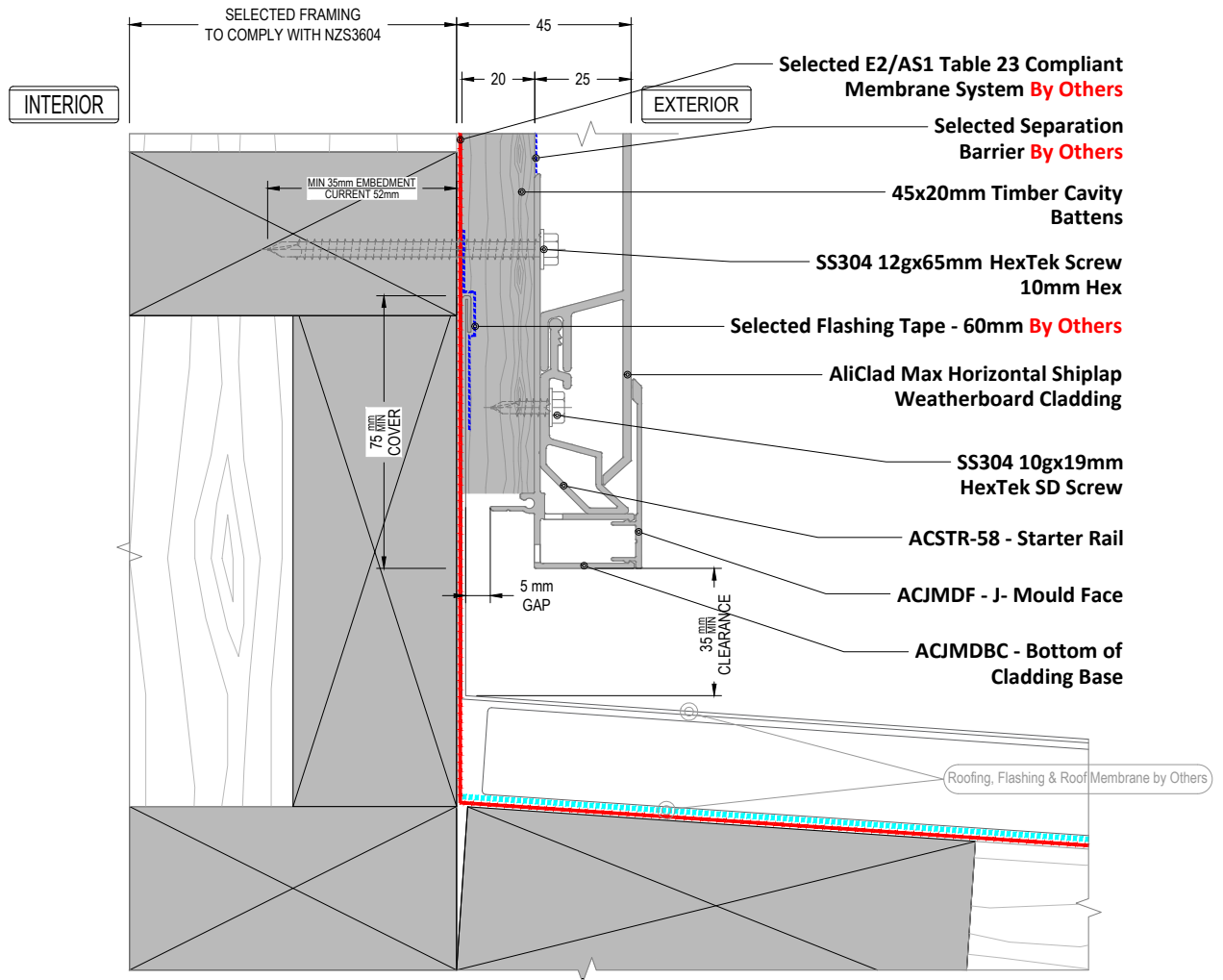

BTM Cladding_ Apron Roof

Detail Number

 AC-H-TB-4.4
 Version

 [V2.2]



MATERIALS • SYSTEMS • SOLUTIONS

ALICLAD MAX

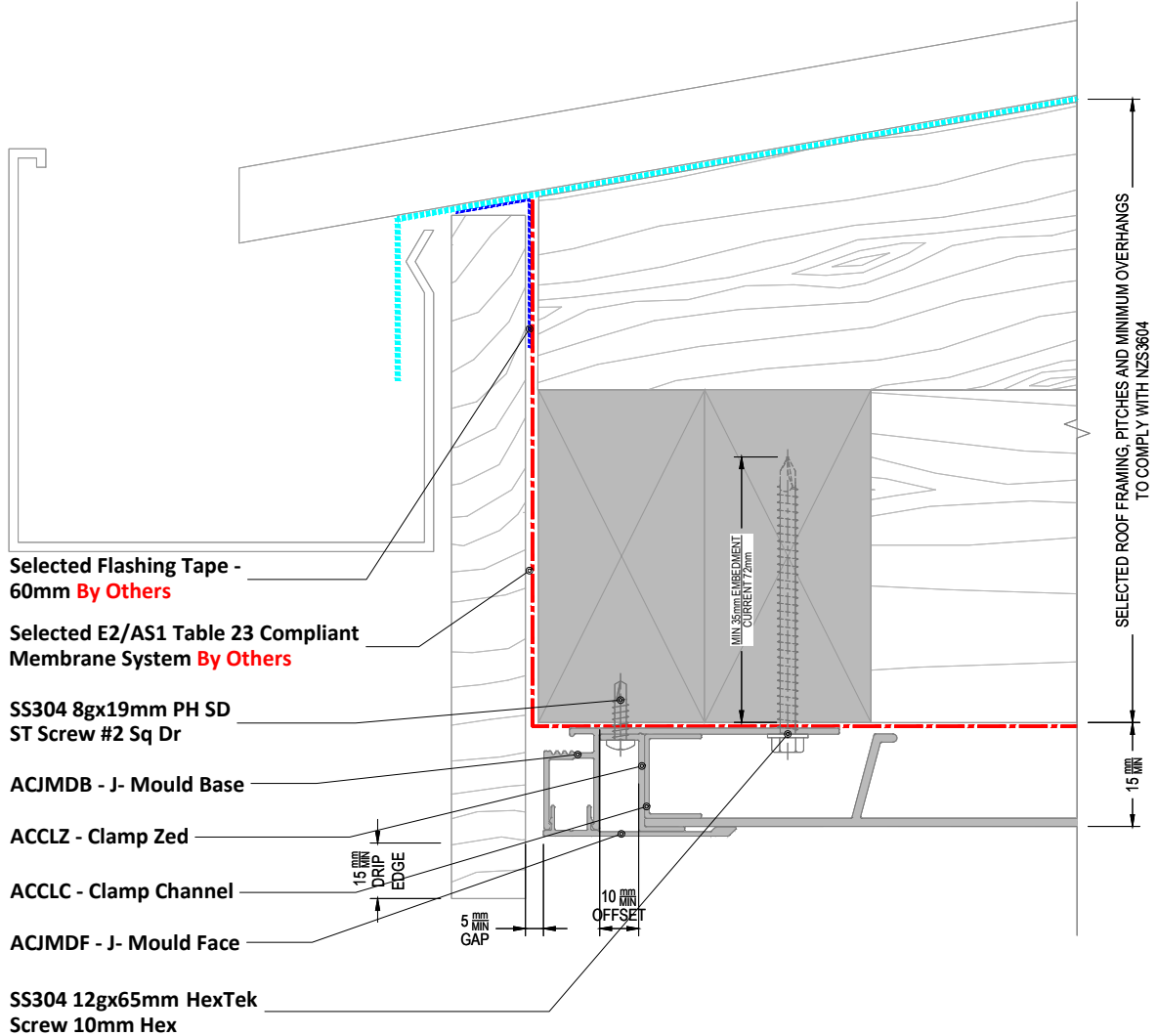

NOTE

Weathering membrane under soffit is not required, but is recommendable for air barrier performance when a rigid wind barrier is not in use.
-By Others

Detail Number

AC-H-TB-4.8

Version

[V2.2]

Top Cladding_Barge/Fascia Board



MATERIALS • SYSTEMS • SOLUTIONS

ALICLAD MAX

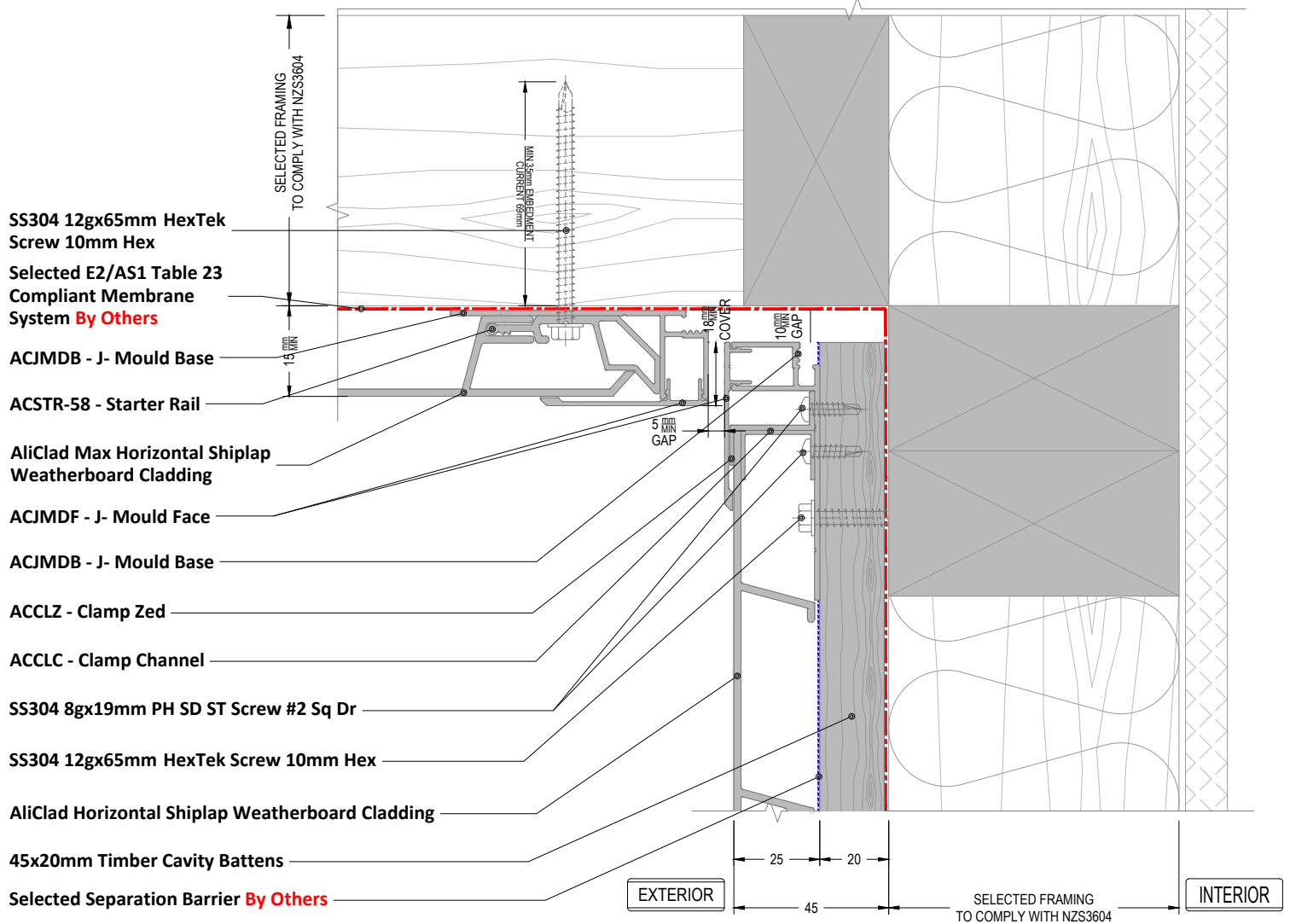

NOTE
 Weathering membrane under soffit is not required, but is recommendable for air barrier performance when a rigid wind barrier is not in use.
 -By Others

Wall BLW_Soffit <90°

Detail Number

 AC-H-TB-5.1
 Version

 [V2.2]



MATERIALS • SYSTEMS • SOLUTIONS

ALICLAD MAX

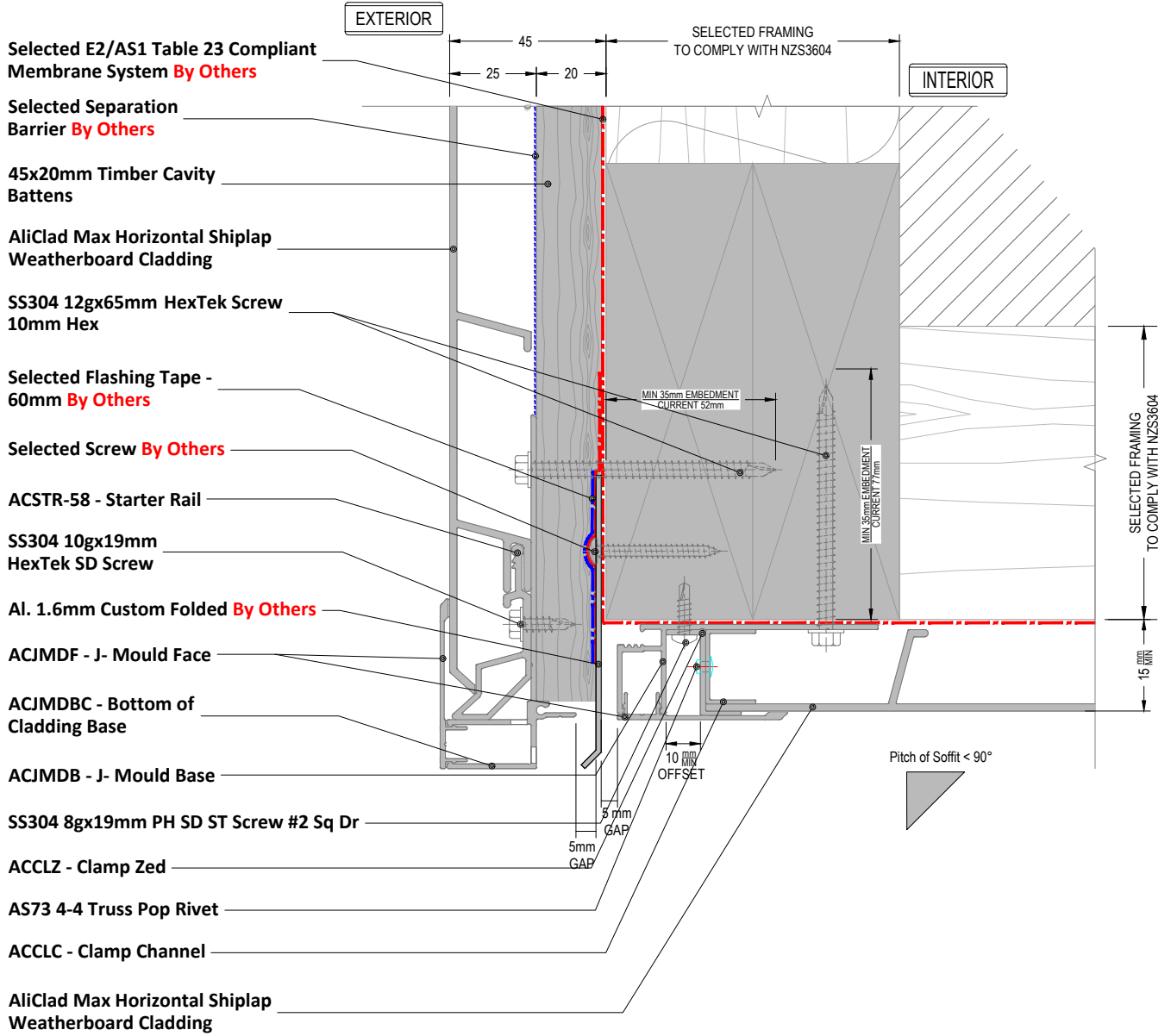

NOTE
Weathering membrane under soffit is not required, but is recommendable for air barrier performance when a rigid wind barrier is not in use. -By Others

NOTE 2
Flashings and Angles are not included in the system

Wall ABV_Soffit <90°

Detail Number
AC-H-TB-5.2

Version
[V2.2]



MATERIALS • SYSTEMS • SOLUTIONS

ALICLAD MAX

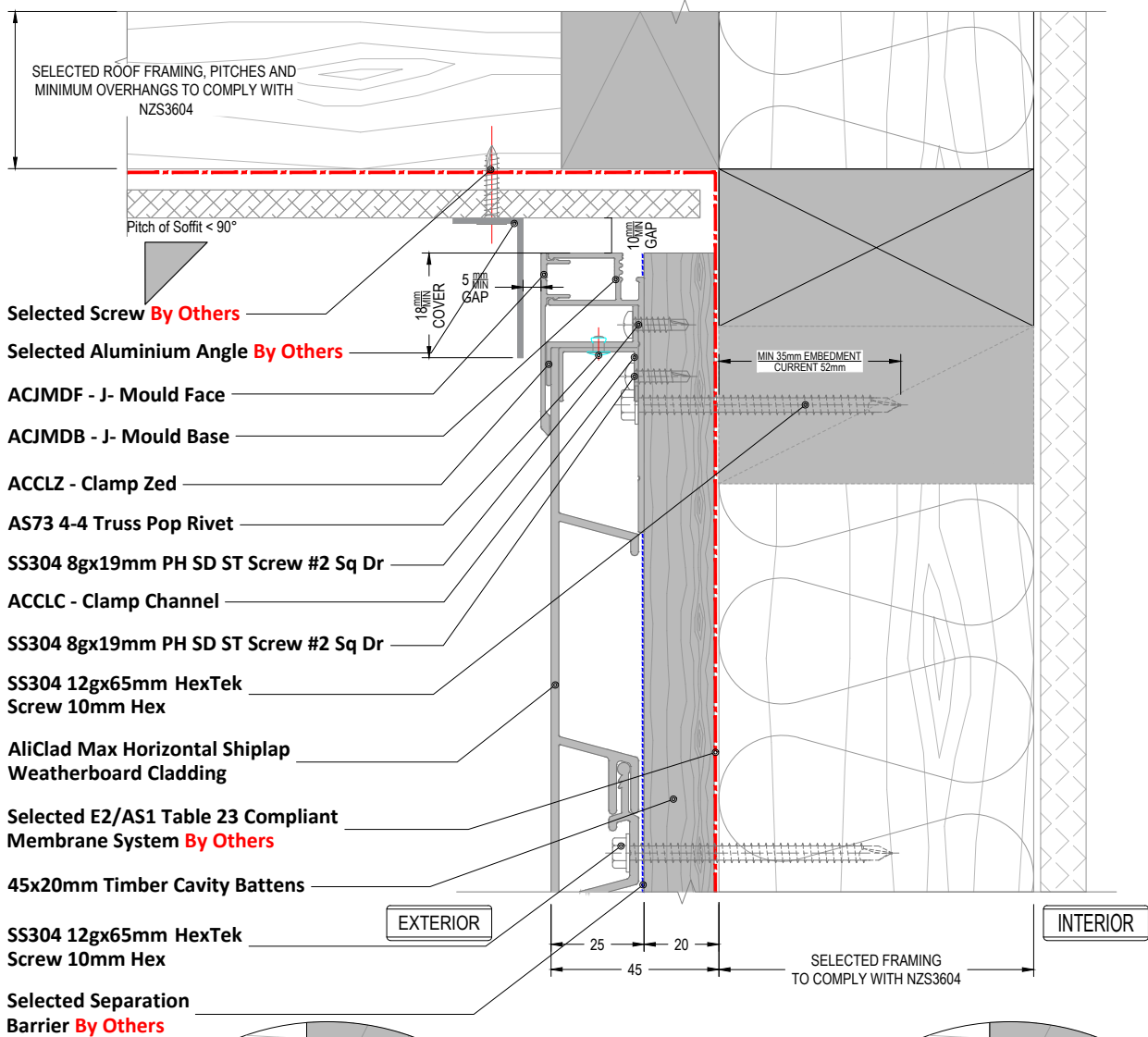

Selected Aluminium Angle **By Others**

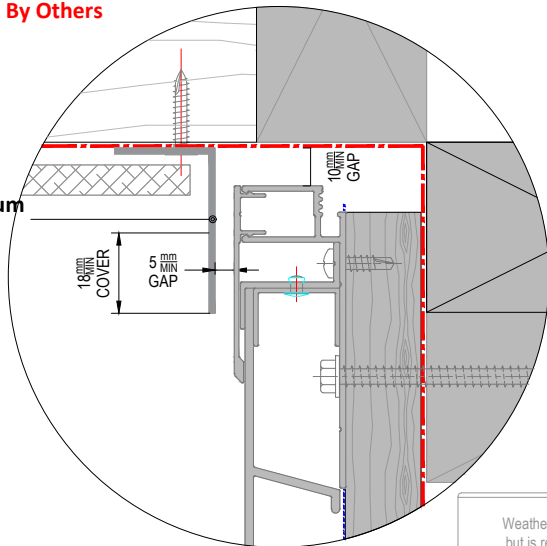

Selected Aluminium Angle **By Others**

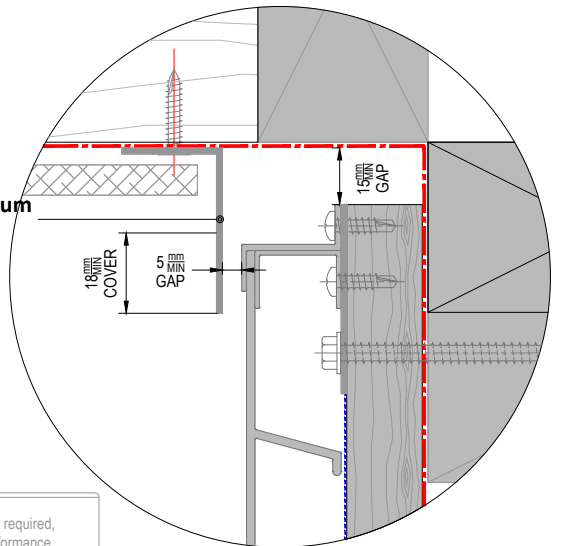

NOTE
Weathering membrane under soffit is not required, but is recommendable for air barrier performance when a rigid wind barrier is not in use. -By Others

NOTE 2
Flashings and Angles are not included in the system

Wall BLW_Flat Sheet Soffit <math>< 90^\circ</math>

Detail Number _____
AC-H-TB-5.6

Version _____

[V2.2]



MATERIALS • SYSTEMS • SOLUTIONS

ALICLAD MAX

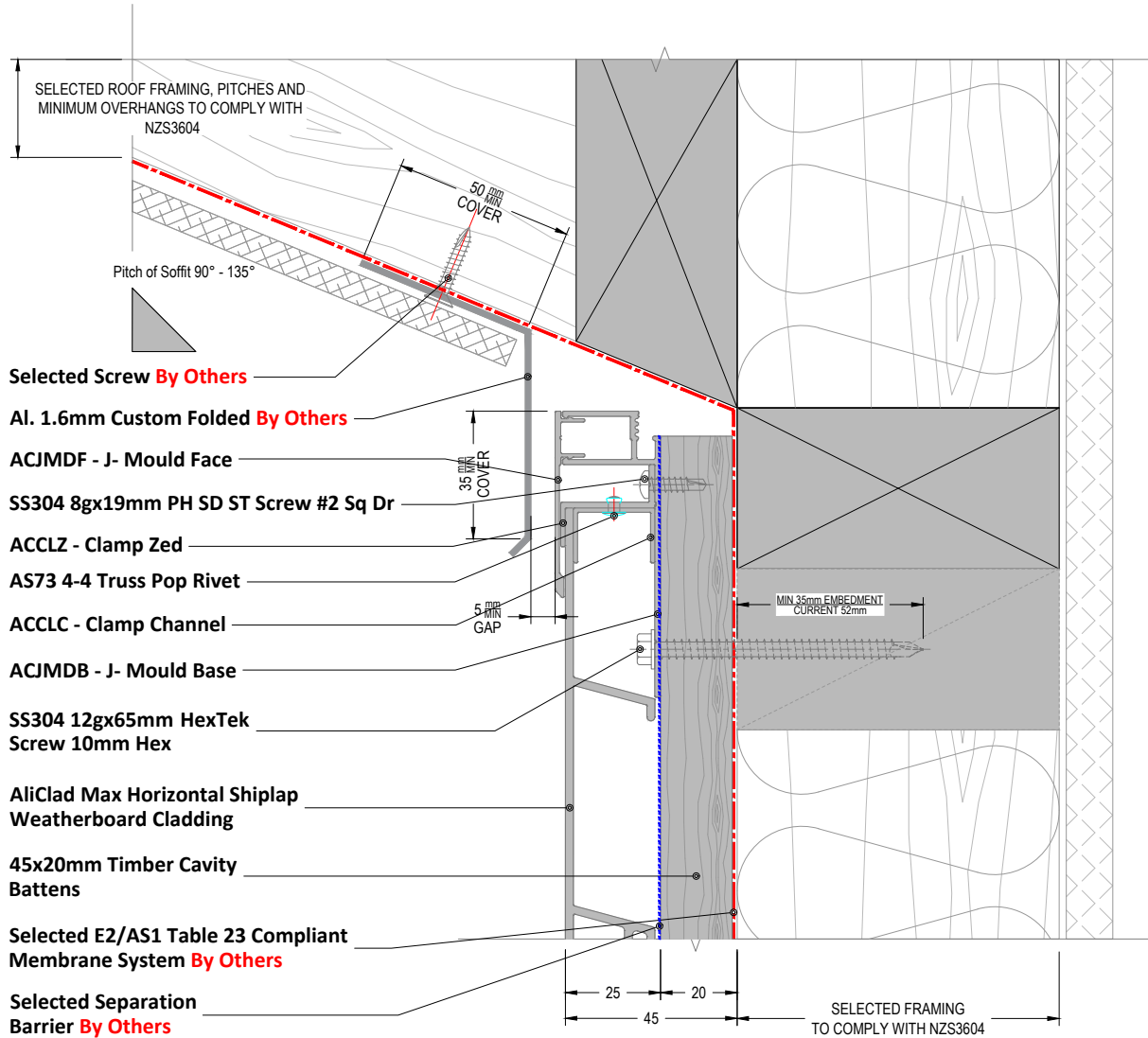

NOTE
Weathering membrane under soffit is not required, but is recommendable for air barrier performance when a rigid wind barrier is not in use. -By Others

NOTE 2
Flashings and Angles are not included in the system

Wall BLW_Flat Sheet Soffit >90°

Detail Number _____
AC-H-TB-5.8

Version _____
[V2.2]



MATERIALS • SYSTEMS • SOLUTIONS

ALICLAD MAX

Wet Seal Adhesion Tape **By Others**

Sill Tape - 150mm **By Others**

SS304 12gx65mm HexTek Screw 10mm Hex

SS304 8gx38mm PH SD Screw #2 Sq.Dr

ACJMC - Jamb Clip

Selected Sealant on PEF Rod to suit gap **By Others**

ACJMF - Jamb Flashing

Selected E2/AS1 Table 23 Compliant Membrane System **By Others**

ACJMDBC - Drained B.o.C. Base

45x20mm Timber Cavity Battens

ACJMDB - J- Mould Base

AliClad Max Horizontal Shiplap Weatherboard Cladding

Selected Separation Barrier **By Others**

6.4mm Closed Cell EPDM Tape **By Others**

ACCLZ - Clamp Zed

SS304 8gx19mm PH SD ST Screw #2 Sq Dr

ACJMDF - J- Mould Face

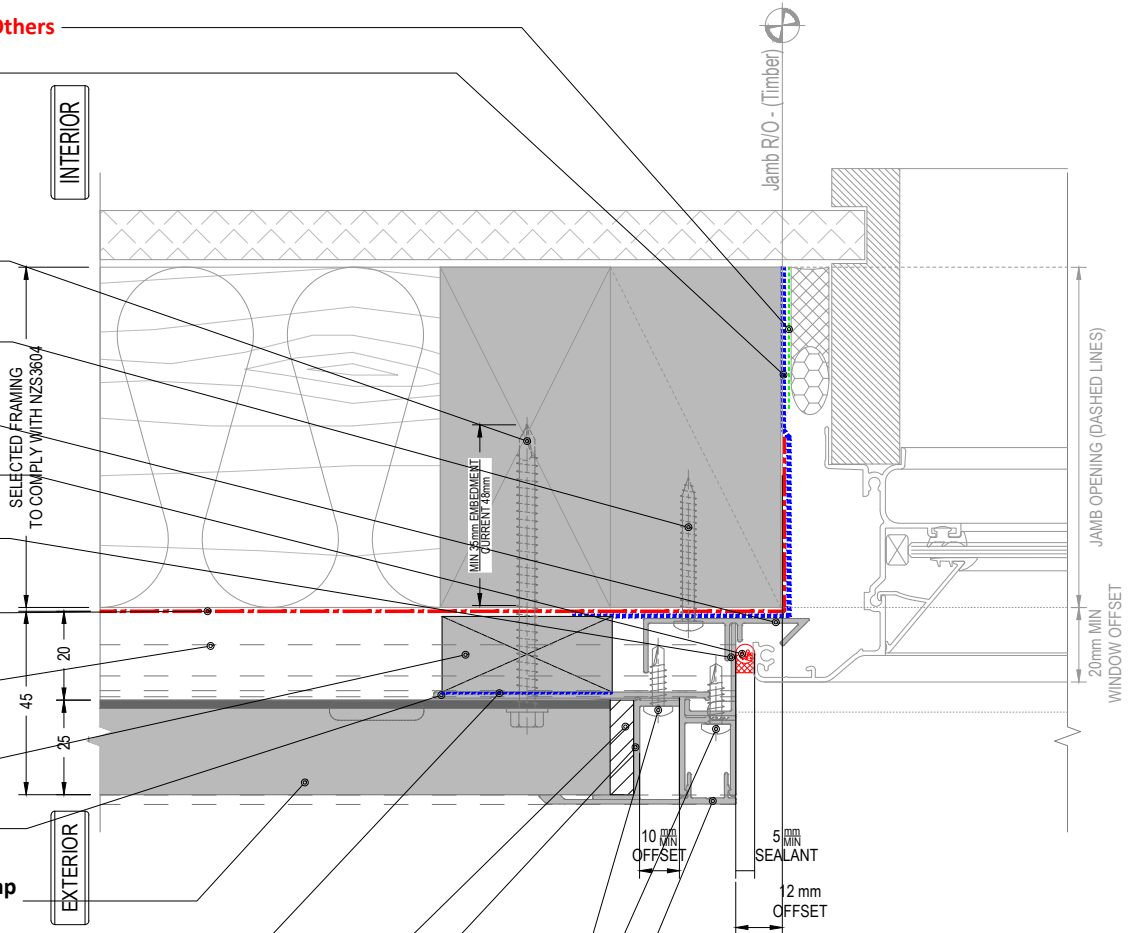

NOTE
ACJMDBC - Drained B.O.C. Base Shown in dashed lines

Window Jamb_Recessed

Detail Number

AC-H-TB-7.1

Version

[V2.2]



MATERIALS • SYSTEMS • SOLUTIONS

ALICLAD MAX

Selected E2/AS1 Table 23 Compliant Membrane System **By Others**

Selected Separation Barrier **By Others**

45x20mm Timber Cavity Battens

AliClad Max Horizontal Shiplap Weatherboard Cladding

SS304 12gx65mm HexTek Screw 10mm Hex

Selected Flashing Tape - 60mm **By Others**

ACSTR-58 - Starter Rail

SS304 10gx19mm HexTek SD Screw

SS304 8gx38mm PH SD Screw #2 Sq.Dr

ACJMDF - J- Mould Face

ACJMDBC - Bottom of Cladding Base

Al. 1.6mm Custom Folded **By Others**

Sill Tape - 150mm **By Others**

Wet Seal Adhesion Tape **By Others**

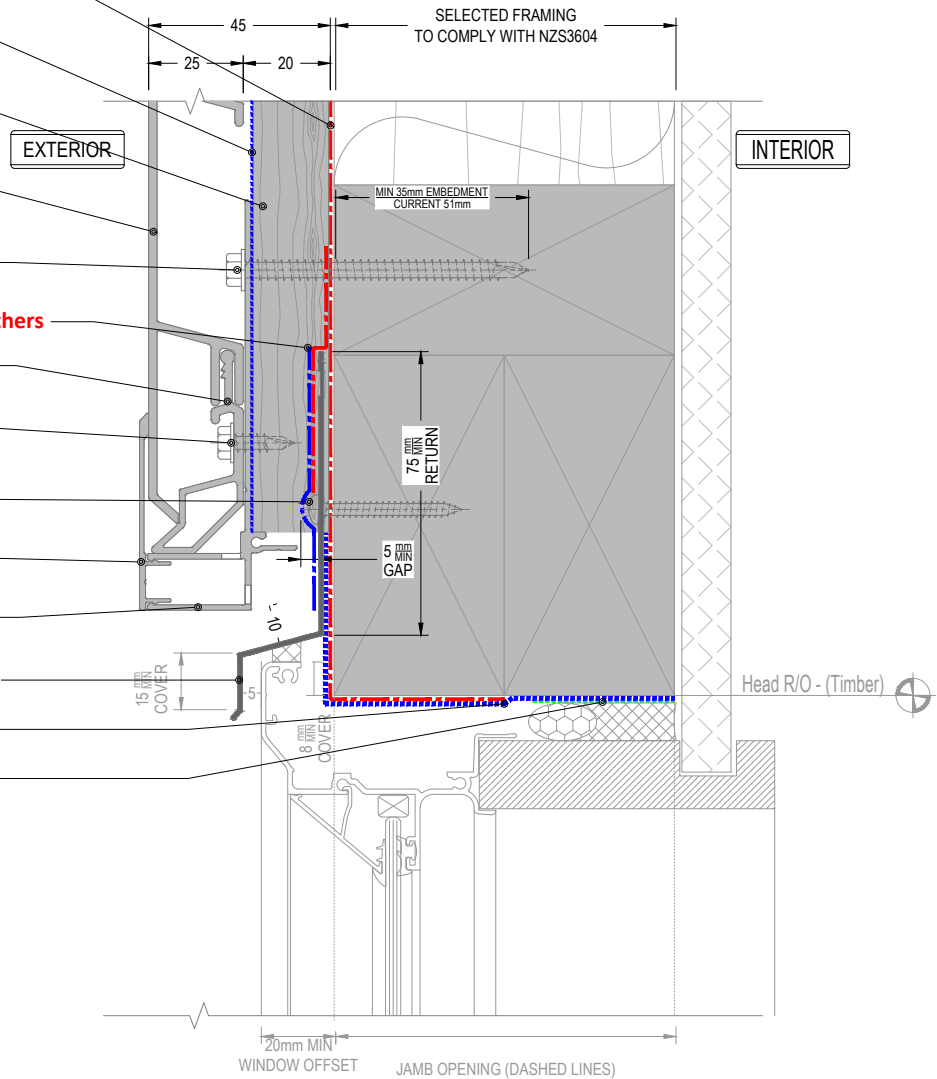

NOTE
Refer to drawing "7.1" for Sill/Jamb Junction

NOTE 2
Flashings and Angles are not included in the system

Window Head_Recessed

Detail Number
AC-H-TB-7.2

Version
[V2.2]



MATERIALS • SYSTEMS • SOLUTIONS

ALICLAD MAX

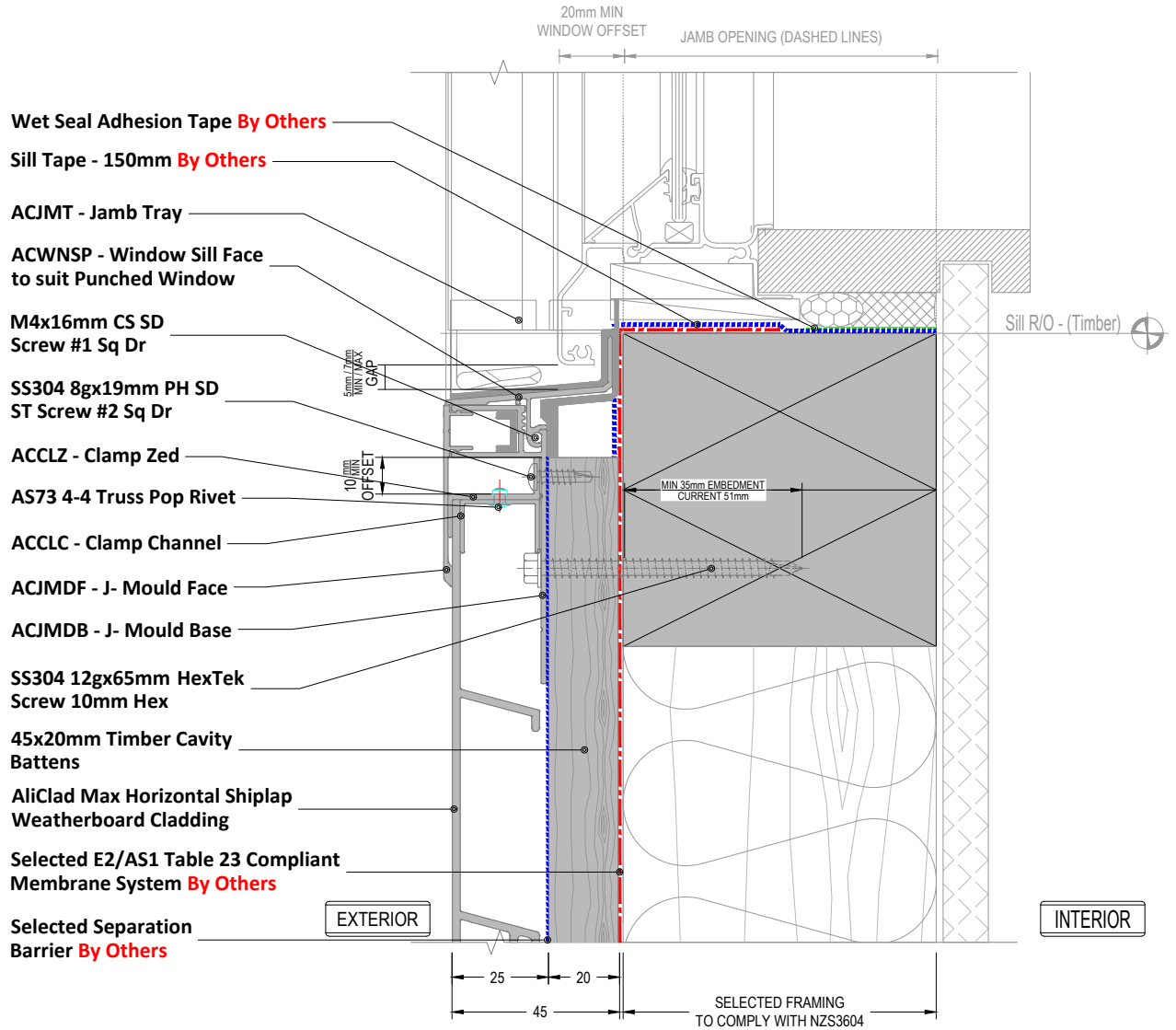

NOTE

Refer to drawing "7.1" for Sill/Jamb Junction

Detail Number

AC-H-TB-7.3

Version

[V2.2]

Window Sill_Recessed



MATERIALS • SYSTEMS • SOLUTIONS

ALICLAD MAX

Wet Seal Adhesion Tape **By Others**

Sill Tape - 150mm **By Others**

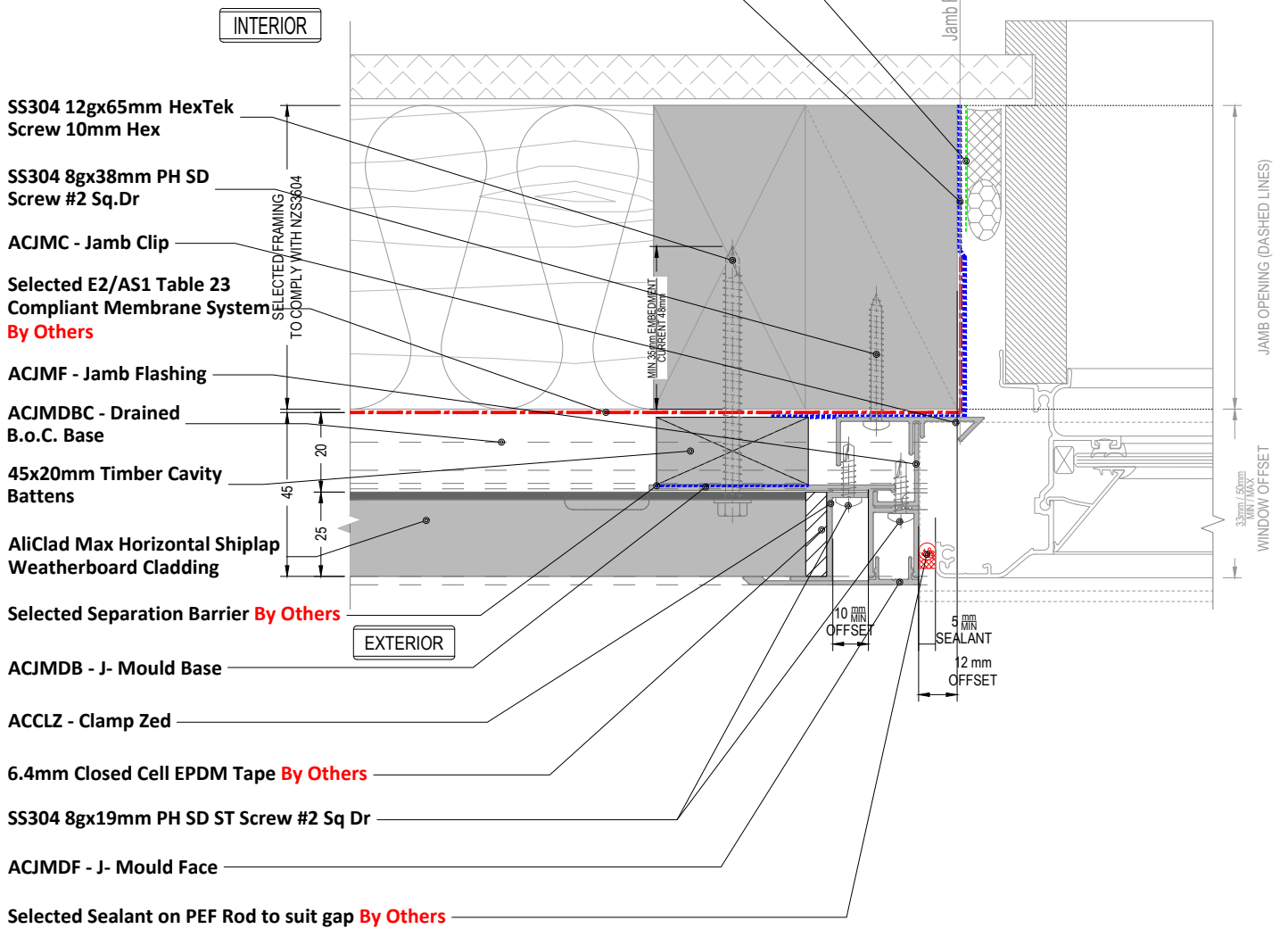

NOTE
ACJMDBC - Drained B.O.C. Base Shown in dashed lines

Window Jamb_WANZ/Supported

Detail Number
AC-H-TB-7.4

Version
[V2.2]



MATERIALS • SYSTEMS • SOLUTIONS

ALICLAD MAX

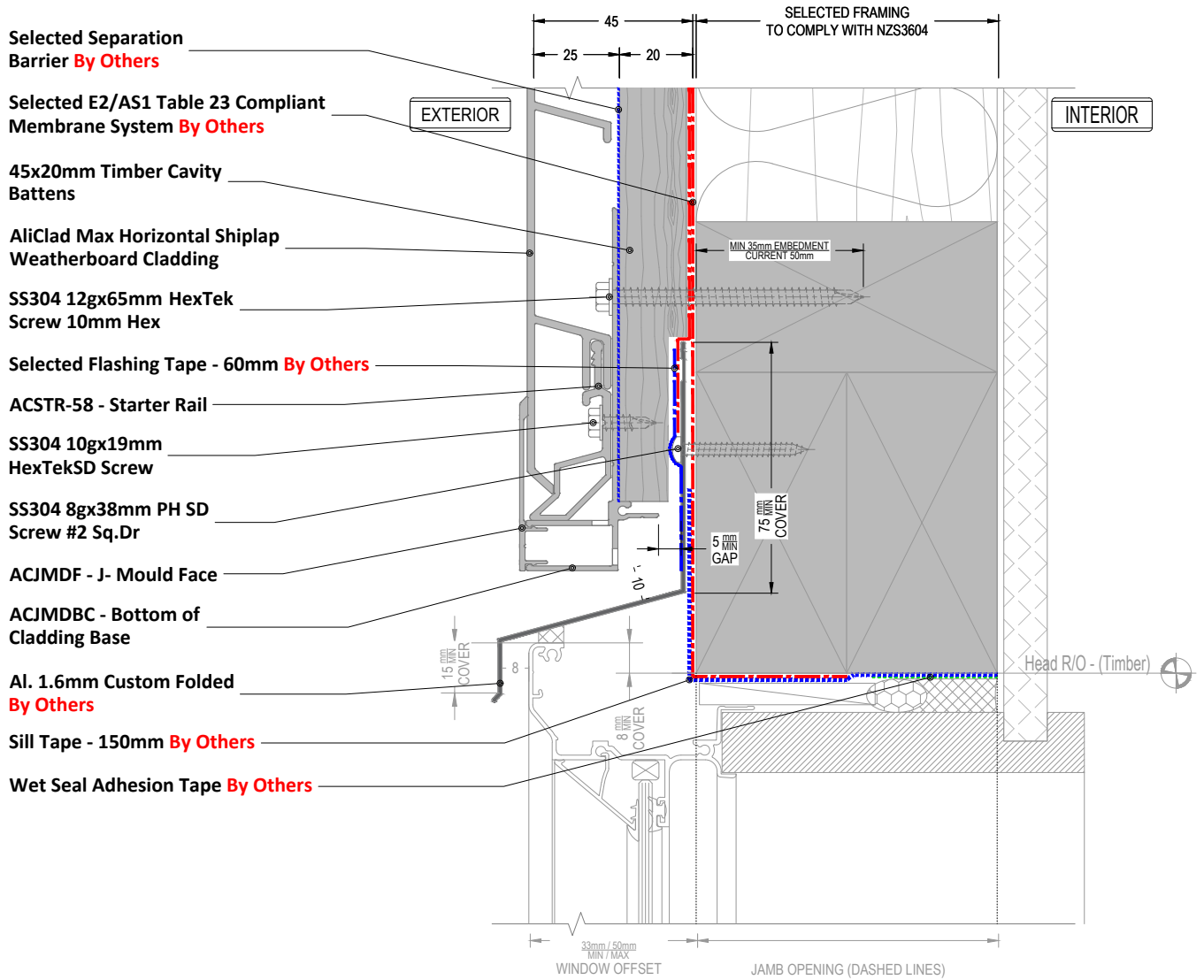

NOTE
Refer to drawing "7.4" for Sill/Jamb Junction

NOTE 2
Flashings and Angles are not included in the system

Window Head_WANZ/Supported

Detail Number
AC-H-TB-7.5

Version

[V2.2]



MATERIALS • SYSTEMS • SOLUTIONS

ALICLAD MAX

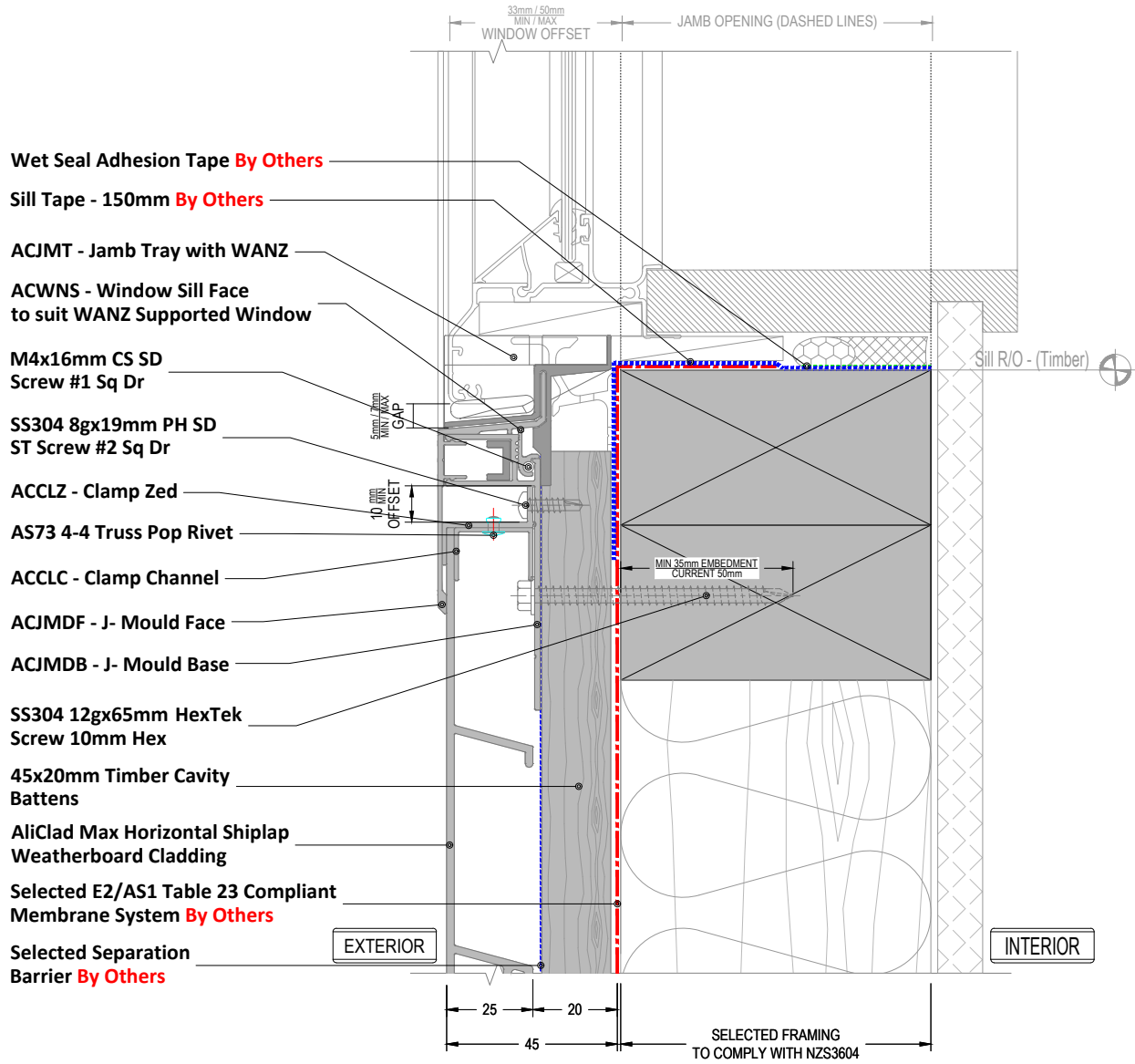

NOTE

Refer to drawing "7.4" for Sill/Jamb Junction

Detail Number

AC-H-TB-7.6

Version

[V2.2]

Window Sill_WANZ/Supported



MATERIALS • SYSTEMS • SOLUTIONS