

**BY  
YOUR  
SIDE®**

Version 1.8 | July 2021



# PERIMETER BARRIERS & FIRESTOPS

For use in curtain walling  
applications

# PERIMETER BARRIERS AND FIRE STOPS FOR CURTAIN WALLING

Siderise CW perimeter barrier and fire stop systems offer an extensive range of solutions for fire stop, smoke stop and sound barrier requirements in all architectural cladding panel applications.

Based on the experience gained through being the premier supplier to the UK curtain walling market, the products represent an unrivalled combination of fully qualified performance, practical installation and service benefits.

The primary function of the CW system is to maintain continuity of fire resistance by sealing the void between the compartment floors or walls and the external curtain wall both horizontally and vertically.

- No. 1 in the UK for over 30 years
- Third-party approved options: Certifire & Intertek certification
- Fully compliant to: UK, EU & UAE regulations
- Fire Resistance to: EN 1364-4, EN 1366-4
- Classified 'A1' to: EN 13501-1

## Benefits

- Market leading fire resistance and smoke seal
- Suitable for horizontal and vertical application
- Unique product construction provides ability to accommodate façade movement
- Fully qualified acoustic performance
- Simple and quick to install



## PRODUCT DESCRIPTION

Siderise perimeter barriers and fire stops for curtain walling use is a unique method of manufacture that provides a resilient lateral compression. This facilitates installation ensuring the requisite tight fit and enhances fire integrity.

The materials throughout the range comprise of a one-piece product with a pre-compressed non-combustible stone wool core. The products also have integral aluminium foil facings to provide an overall Class A1 rating (to EN 13501-1) and excellent resistance to smoke.

The systems can offer tested fire rating options ranging from 30mins to 3 hours and can accommodate void widths up to 600mm.

In addition to providing an effective seal against the passage of smoke and fire the products will also function as an effective acoustic barrier and plenum lining.

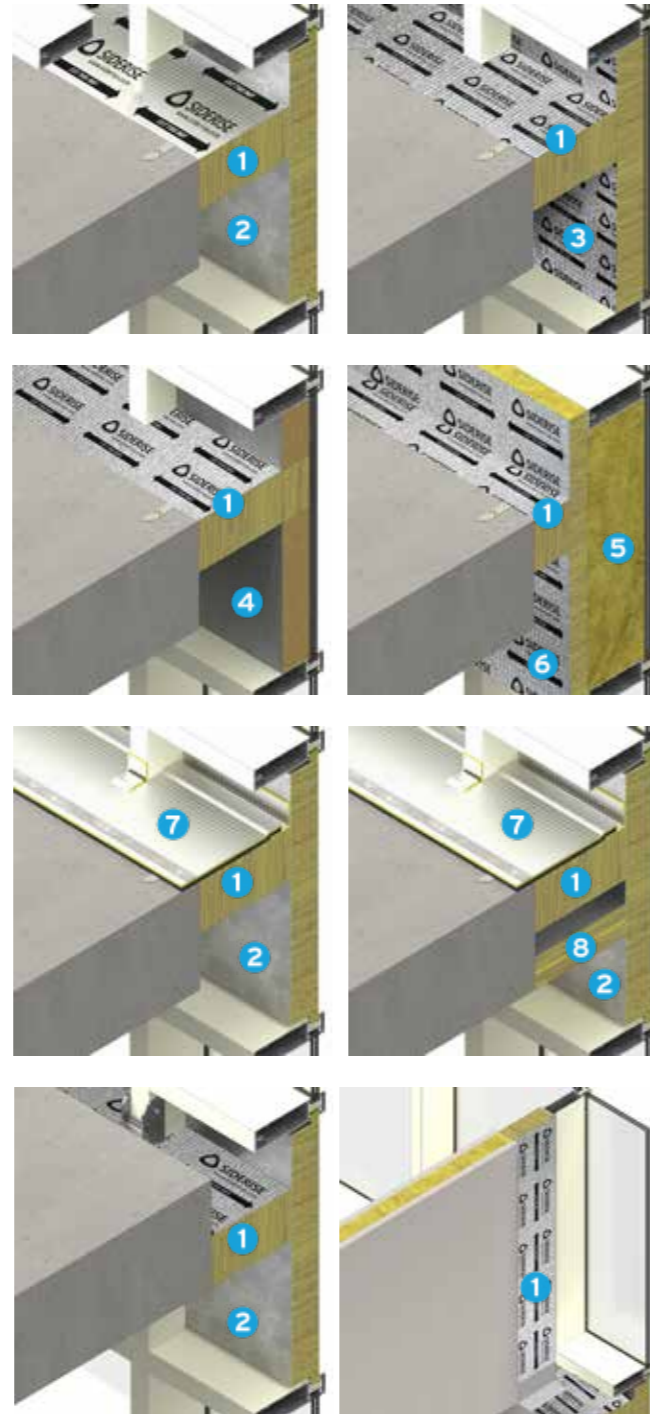

1 Siderise Cavity Barrier (CW-CB) or Siderise Fire Stop (CW-FS)

2 Metal spandrel panel with Siderise Nexus 'Core'

3 Siderise Nexus 'Fusion'

4 Insulation other than Class A1

5 Siderise Nexus or Class A1

6 Siderise CW-FB Curtain Wall Fire Board

7 Siderise CW-AB Acoustic Barrier Overlay

8 Siderise CVB/C Acoustic Void Barrier

### Standard systems

The materials can be either supplied as pre-cut units to suit a specified void size or in sheet form for cutting on site.

#### Sheets

- Standard sheet products are supplied 1200 x 1200mm which may prove beneficial when the actual void size is not known or where it varies significantly. Please note when ordered in sheet form, the requisite quantity of fixing brackets needs to be purchased separately.

#### Pre-cut Strips

- Pre-cut products are available in 1mm increments of width to suit the cavity size. Please see Tables 1, 2 & 3 regarding 'fit type'.
- Supplied with appropriate brackets as part of a system

The standard fixing brackets are supplied in 1mm galvanised mild steel in flat form that is complete with a pre-notched facility for folding on site.

All holes are to be drilled to suit the varying site conditions. Different size brackets are available according to the cavity size – please see Tables 1 to 3.

All fixing brackets are to be mechanically secured to the substructure with suitable non-combustible fixings.

### Fire performance

#### Reaction to fire

Siderise CW Cavity Barriers and Fire Stops have been tested for non-combustibility and classified 'A1' to EN 13501-1.

#### Resistance to fire

Siderise CW systems have been tested to EN 1364-4 and EN 1366-4 for fire resistance, and classified to EN 13501-2.

Siderise CW systems provide continuity of fire resistance across the void when aligned with fire rated elements to maintain compartmentation.

The correct system is simply selected by matching the fire resistance requirements to the CW system type and void size.

Tables 1 to 3 summarise the void sizes, fire resistance classifications to EN 13501-2, and provide 3rd Party Certification details where applicable.

Approved Document B – England & Wales

Approved Document B for England & Wales (2019 edition) gives classification to EN 13501-2 as the primary route to compliance.

BS 476-20 remains as an alternate route to compliance.

Siderise CW systems have additionally been tested and assessed to BS 476-20. For any voids not covered by Tables 1 to 3, please contact **technical.services@siderise.com** for advice on these options.

### Third party certification

Certifire Certification has been achieved based on proven fire performance, for horizontal applications to EN 1364-4 (Table 1), and horizontal and vertical applications to EN 1366-4 (Table 2 & 3).

For further details, Certifire Certificate 'CF 563' can be downloaded from [www.siderise.com](http://www.siderise.com)

Intertek Certification has also been achieved based on reaction to fire performance to EN 13501-1, and fire resistance to EN 1364-4 for horizontal applications (Table 1).

For further details, Intertek Certificates 'WH120-32944302' (EN 13501-1) and 'WH119-32944301' (EN 1364-4) can be downloaded from [www.siderise.com](http://www.siderise.com).

Table 1: Fire Resistance to EN 1364-4\* (Horizontal Orientation)

Void Width (mm)	Product Ref.	Product Thickness	Compression (minimum)	Cover Length (mm)	Bracket Requirement	Classification (EN 13501-2)	3rd Party Approval
20 to 50	CW-FS120	120mm	+10%	1200	2 no. B65/110 600mm centres	EI 120	Certifire 'CF 563' Intertek 'WHI19-32944301'
	CW-FS180	150mm				EI 180	
51 to 150	CW-FS120	120mm	+10%	1200	2 no. B65/110 600mm centres	EI 120	Certifire 'CF 563' Intertek 'WHI19-32944301'
	CW-FS180	150mm				EI 180	
151 to 250	CW-FS120	120mm	+10%	1200	2 no. B195 600mm centres	EI 120	Certifire 'CF 563' Intertek 'WHI19-32944301'
	CW-FS180	150mm				EI 180	

NOTE: All fixing brackets are to be mechanically fixed to structure. Please see separate installation instructions.

Table 2: Fire Resistance to EN 1366-4 (Horizontal Orientation)

Void Width (mm)	Product Ref.	Product Thickness	Compression (minimum)	Cover Length (mm)	Bracket Requirement	Classification (EN 13501-2)	3rd Party Approval
20 to 50	CW-CB30	75mm	+10%	1200	None	EI 30	Certifire 'CF 563'
	CW-FS60	90mm				EI 60	
	CW-FS120	120mm				EI 120	
51 to 150	CW-CB30	75mm	+10%	1200	2 no. B65/110 600mm centres	EI 30	Certifire 'CF 563'
	CW-FS60	90mm				EI 60	
	CW-FS120	120mm				EI 120	
151 to 250	CW-CB30	75mm	+10%	1200	2 no. B195 600mm centres	EI 30	Certifire 'CF 563'
	CW-FS60	90mm				EI 60	
	CW-FS120	120mm				EI 120	
251 to 300	CW-CB30	75mm	+10%	1200	2 no. B355 600mm centres	EI 30	Certifire 'CF 563'
	CW-FS60	90mm				EI 60	
	CW-FS120	120mm				EI 120	
301 to 600	CW-FS60-X	120mm	+10%	1200	2 no. B355 600mm centres	EI 60	Certifire 'CF 563'

NOTE: All fixing brackets are to be mechanically fixed to structure. Please see installation instructions.

Table 3: Fire Resistance to EN 1366-4 (Vertical Orientation)

Void Width (mm)	Product Ref.	Product Thickness	Compression (minimum)	Cover Length (mm)	Bracket Requirement	Classification (EN 13501-2)	3rd Party Approval
20 to 50	CW-CB30	75mm	+10%	1200	None	EI 30	Certifire 'CF 563'
	CW-FS60	90mm				EI 60	
	CW-FS120	120mm				EI 120	
51 to 150	CW-CB30	75mm	+10%	1200	2 no. B65/110 600mm centres	EI 30	Certifire 'CF 563'
	CW-FS60	90mm				EI 60	
	CW-FS120	120mm				EI 120	
151 to 250	CW-CB30	75mm	+10%	1200	2 no. B195 600mm centres	EI 30	Certifire 'CF 563'
	CW-FS60	90mm				EI 60	
	CW-FS120	120mm				EI 120	
251 to 300	CW-CB30	75mm	+10%	1200	2 no. B355 600mm centres	EI 30	Certifire 'CF 563'
	CW-FS60	90mm				EI 60	
	CW-FS120	120mm				EI 120	
301 to 450	CW-CB30	75mm	+10%	1200	2 no. B355 600mm centres	EI 30	Certifire 'CF 563'
	CW-FS60	90mm				EI 60	
	CW-FS120	120mm				EI 120	
451 to 600	CW-FS60-X	120mm	+10%	1200	2 no. B355 600mm centres	EI 60	Certifire 'CF 563'

NOTE: All fixing brackets are to be mechanically fixed to structure. Please see installation instructions.

**Acoustic performance**

The CW range additionally provides an effective sound barrier as the material construction and inherent properties of the stone wool core afford the CW exceptional acoustic performance.

Also, the foil facings coupled with the additional sealing of joints with Siderise foil tape all serve to provide improved air tightness.

**Sound reduction between floors**

The installation of the CW systems within an external curtain wall cavity will significantly increase the floor-to-floor attenuation.

As an example, the installation of 120mm thick CW-FS120 within the cavity will increase the transmission loss via the tortuous sound path by approximately 25dB.

The precise value will depend upon the specifics of the construction.

Table 4 confirms values for Weighted Sound Reduction Index (Rw) based on laboratory tests to determine airborne sound transmission in accordance with BS EN ISO 140-3 : 1995, BS 2750 Pt 3 :1995.

**Enhanced acoustic performance AB acoustic barriers**

Siderise offer a range of complementary acoustic mass overlay materials

which can further enhance the overall acoustic performance of the construction.

AB barriers are extremely quick and easy to install and are suitable for improving sound performance within all curtain walling environments.

The AB acoustic barriers are factory produced multi-layer composite materials consisting of an aluminium foil faced polymeric layer bonded to a flexible acoustic foam. The products are available in two grades depending on the acoustic performance requirement, namely AB5 and AB10 whenever façade deflection is anticipated.

**Table 4: CW acoustic performance**

Weighted Sound Reduction Index		
Product Type	Thickness (mm)	Rw (dB)
CW-CB30	75	21
CW-FS60	90	22
CW-FS120	120	25
CW-FS180	150	26*

**NOTE:** \*Assessed values by either UKAS accredited Laboratories or IOA registered Acoustic Engineers

**Table 5: AB acoustic performance**

Weighted Sound Reduction Index		
Product Type	Surface mass (mm)	Rw (dB)
AB5	5 kg/m <sup>2</sup>	25
AB10	10 kg/m <sup>2</sup>	28

**Table 6:** The table below illustrates typical CW and AB acoustic performance of a range of different curtain wall fire stopping products, including products manufactured by Siderise.

Product	21 - 30dB Rw		31 - 35dB Rw		36 - 50dB Rw		50dB Rw +	
	Rw	Rw + Ctr	Rw	Rw + Ctr	Rw	Rw + Ctr	Rw	Rw + Ctr
Siderise CW-FS60	23	21	—	—	—	—	—	—
Siderise CW-FS120 <span style="color:purple">●</span>	25	23	—	—	—	—	—	—
Siderise CW-FS60 + AB5 Overlay	—	—	33	27	—	—	—	—
Siderise CW-FS120 + AB5 Overlay	—	—	33	27	—	—	—	—
Siderise CW-FS60 + AB10 Overlay	—	—	—	—	36*	31*	—	—
Siderise CW-FS120 + AB10 Overlay <span style="color:orange">●</span>	—	—	—	—	37	32	—	—
Siderise CW-FS120 + AB10 Overlay + CVB/C10 below <span style="color:yellow">●</span>	—	—	—	—	—	—	51	45
Siderise CW-FS120 + 2mm Steel Plate Overlay + CVB/C10/75 below	—	—	—	—	—	—	53	45

**NOTE:** \*Assessed values by either UKAS accredited Laboratories or IOA registered Acoustic Engineers

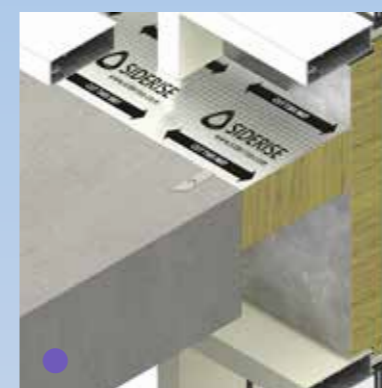

Siderise CW-FS120



Siderise CW-FS120 + AB10 Overlay

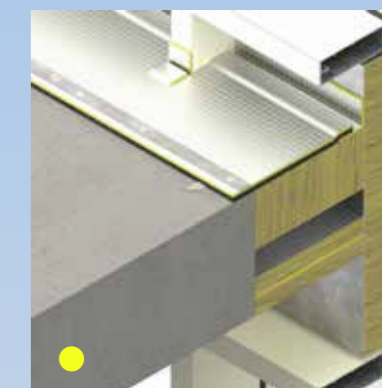

Siderise CW-FS120 + AB10 Overlay + CVB/C10 below

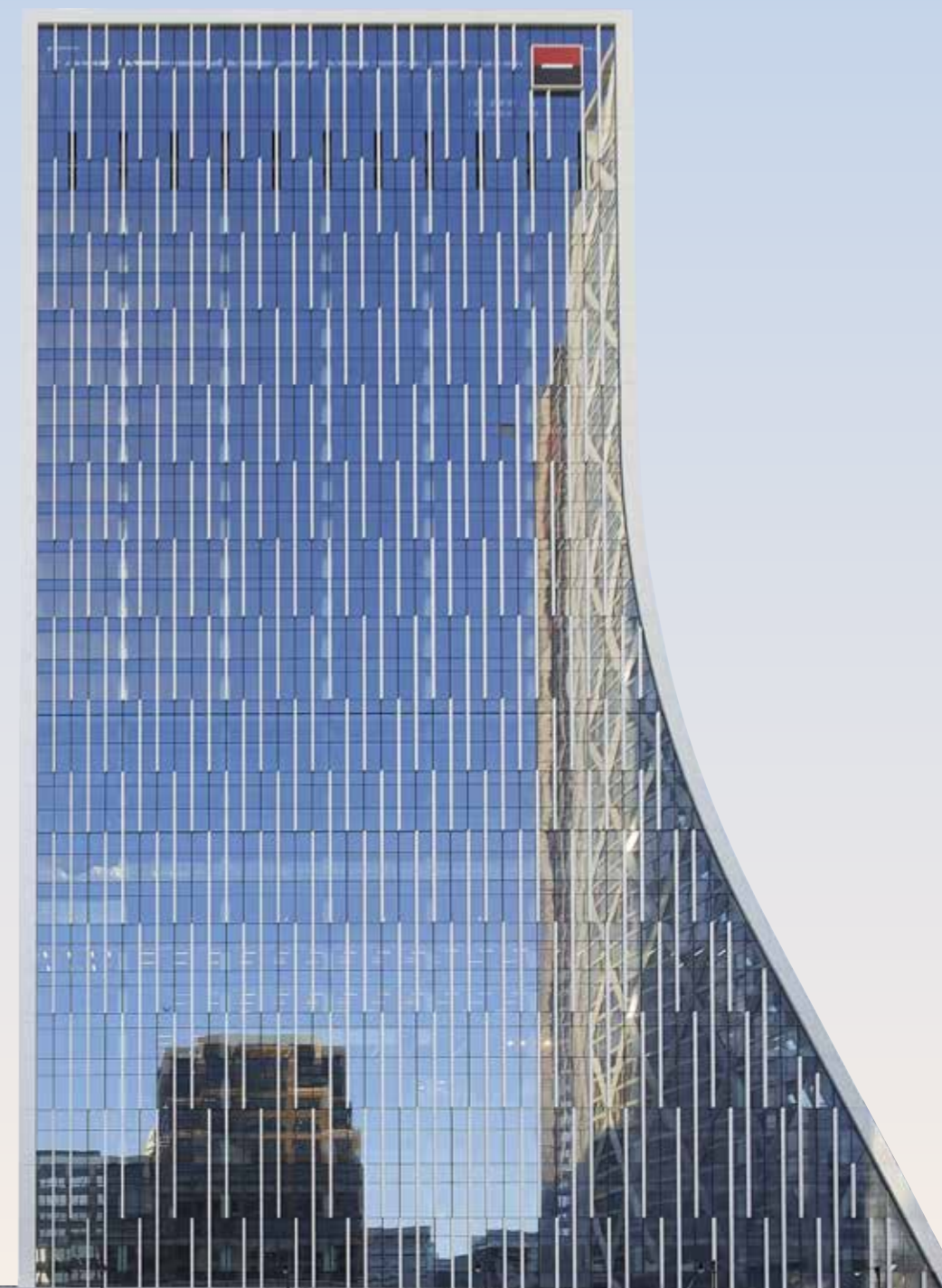

Societe Generale, London



### Installation recommendations

Siderise CW is installed using necessary compression and fixing brackets (see tables 1-3) which are impaled into the material at mid-thickness at nominal 600mm fixing centres i.e. 300mm from each end.

For horizontal applications the cut strips are then inserted within the void with the fixing brackets located over the edge of the concrete floor slab.

The brackets must be mechanically fixed to the compartment floor or wall, with suitable non-combustible fixings.

The CW is built into the void to provide the necessary compression as per Tables 1 to 3. It's crucial that there are no gaps.

Ensure that there are no gaps and that all joints, including the intersections of horizontal / vertical installation, are tightly abutted and sealed with Siderise foil tape to ensure the integrity of the smoke barrier. As a minimum the topside is only sealed with Siderise foil tape, the juncture between façade and floor or wall need not be sealed.

### Fixing brackets

A range of support brackets for Siderise CW-FS horizontal perimeter barriers are available for void widths of up to 600mm (see Tables 2 and 3 for appropriate type and quantity).

The fixing brackets should be trimmed if necessary to approximately 75% of the cavity width. The standard fixing brackets are supplied in 1mm galvanised mild steel in flat form that is complete with a pre-notched facility for folding on site. Stainless steel brackets can be quoted and provided upon request. All holes are to be site drilled to suit the varying site conditions.

Where the void is smaller than the section available, the CW-CB/CW-FS can be trimmed on site with a sharp serrated knife providing that the compression allowance is maintained. Also, if used in sheet form, the product must be cut to provide the requisite compression fit.

### Installation principles

The CW material must be installed with the un-faced stone wool in contact with the sides of the cavity, the aluminium foil smoke barrier facings will be positioned top and bottom i.e. remains visible to the installer. For all installations the CW seals are to be sized to provide the correct compression allowance. See Tables 1 to 3.

### Installation considerations

As standard, the CW material must be compressed within the void to maintain the integrity of the seal.

For vertical applications where the façade deflection may be up to 15mm, we recommend that you calculate the design deflection of the external façade system in both positive and negative wind load situations. Then follow Tables 1 to 3 + the design deflection of the system.

Additional material allowances should be included whenever façade deflection is anticipated. For example:

CW-CB/CW-FS + Deflection + Compression

CW-CB/CW-FS to suit void + 15mm + 10mm = CW-CB/CW-FS to suit void + 25mm

Therefore for 120mm void = 120mm + 15mm + 10mm = 145mm of CW-CB/CW-FS

### Installation detailing

For the interface with the mullion condition we recommend that the CW is trimmed to accommodate the mullion with the joint between adjacent product being along the centre line of the mullion.

For curtain wall systems with mullion centres in excess of 1200mm, we recommend the use of standard 1200mm CW-CB/CW-FS trimmed to accommodate the mullion, together with a smaller section of CW-CB/CW-FS trimmed to accommodate the mullion.

Please note that the smaller 300mm CW-CB/CW-FS length is secured with two fixing brackets. We specify that all small portions of CW-CB/CW-FS are fixed with two fixing brackets as part of the system.

For the interface with the spandrel panel at the mullion position we recommend the use of a cut portion of CW product to suit the void (cut oversize to maintain compression). This is then bonded into position with Siderise fire and acoustic gap sealant.

Smaller voids and/or particularly difficult situations can be treated by the additional application of Siderise fire and acoustic gap sealant to make good joints, areas of missing material or complex details.

The CW material is easily cut on site with a sharp serrated knife to form a tight resilient seal around mullion details and structural brackets etc.

### Movement characteristics

Curtain walling and external façade deflection

The qualification of proprietary fire stop systems are typically limited by the condition that they must be installed in a static environment.

However, for curtain walling applications it is imperative that the installed seal is able to function effectively with due regard to all designed movement serviceability limits. Siderise recognise that curtain walling and cladding façade systems will deflect due to:

- Positive wind-load
- Negative wind-load
- Occupational live load

The above are covered by EN 13116:2001

Typically, a project may stipulate that the curtain walling system may have the following allowable deflection limits:

Under the declared wind loads the maximum frontal deflection of the curtain walling's framing members shall not exceed  $L/200$  or 15mm, whichever is the less, when measured between the points of support or anchorage to the building's structure in compliance with EN 13116. [Extract from EN 13830]

These factors may inevitably combine to preclude the suitability and therefore, use of certain systems e.g. high density material slab products.

However, the CW perimeter barriers and fire stop systems are very effective in their function within curtain walling as the unique material construction can accept the cyclical negative and positive wind and live loads imposed on the façade.

### Design considerations

Important factors to consider for the application of fire stops within curtain wall façades:

- Review the position of firestop and distance from fixing bracket connection.
- Ensure structural engineer specifies the façade deflection.
- Review the curtain wall expansion and any floor slab/building movement.
- Review transom/mullion deflection.

Upon confirmation and consideration of the above parameters, the required fire stop compression factor can be assessed for the specific project application.

**Note 1:** Siderise CW vertical fire stop systems can accommodate façade deflection due to their unique construction. However, material size is crucial to ensure that integrity is maintained.

**Note 2:** On a project basis, consider both inward and outward deflection requirements for the system.

Horizontal perimeter barrier installation: CW-FSH-01-A

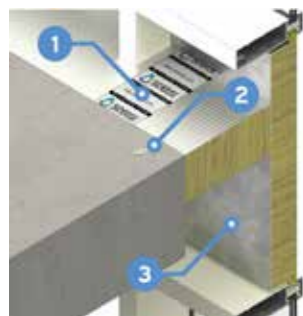
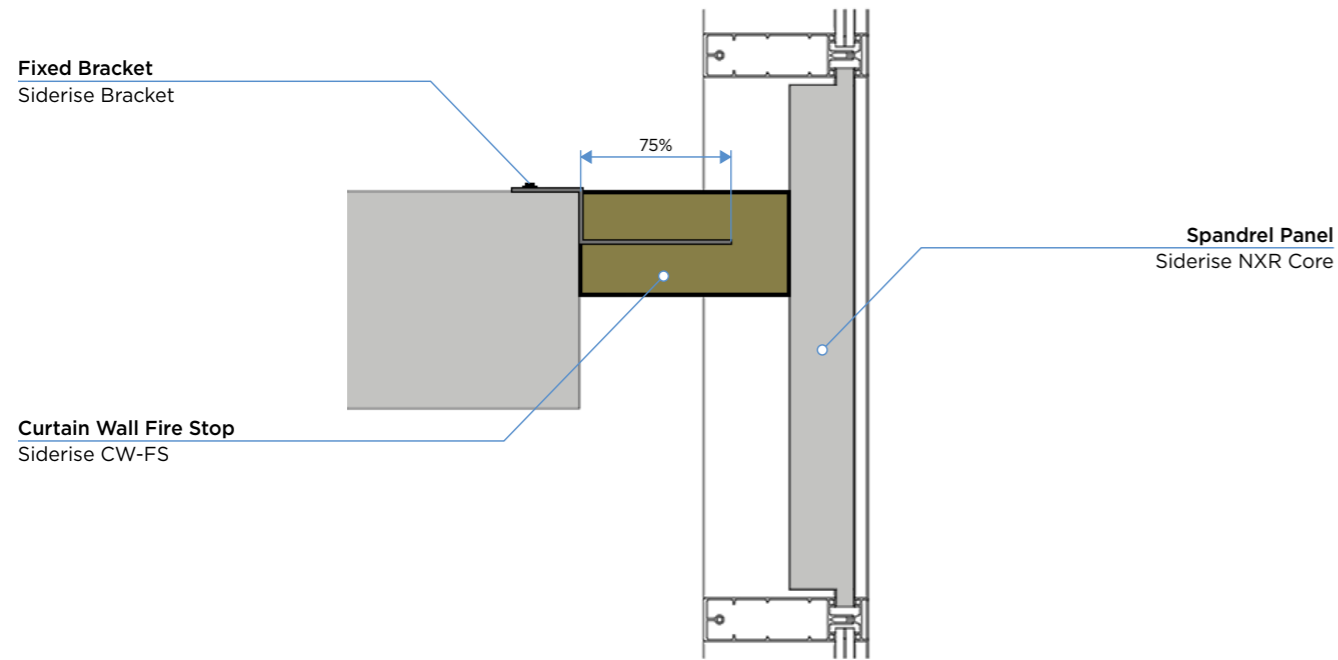
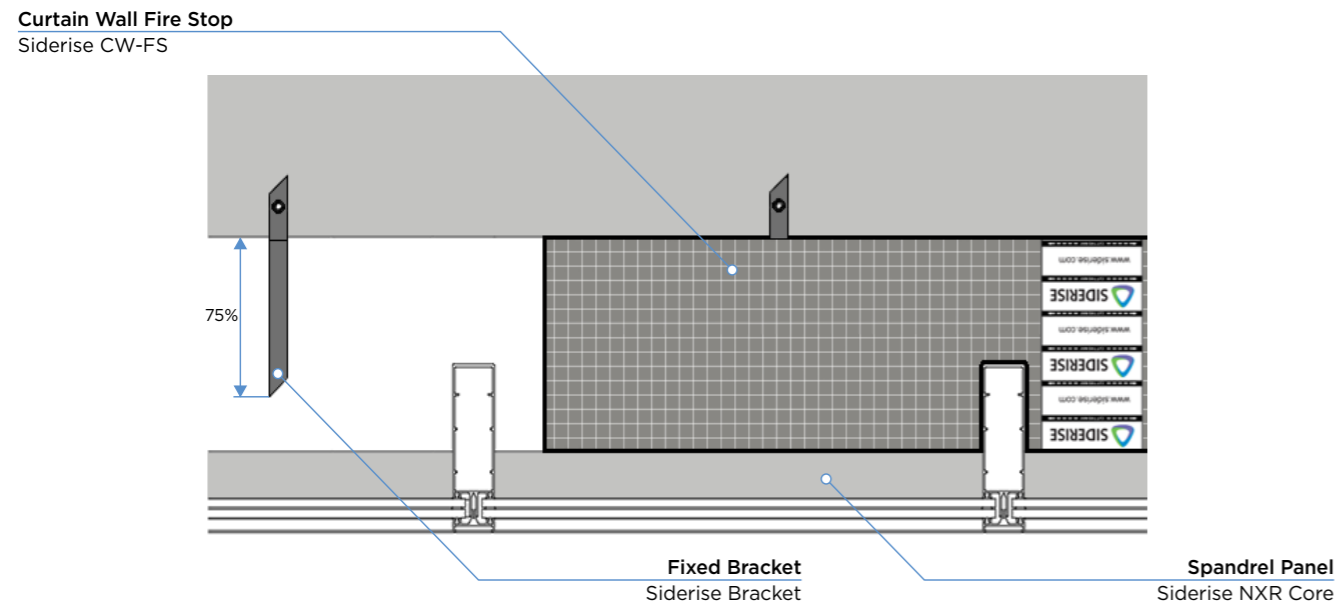

Products used

- 1 Siderise curtain wall fire stop CW-FS
- 2 Siderise support brackets
- 3 Siderise Nexus Core 'NXR'

Horizontal perimeter barrier installation: CW-FSH-02-A

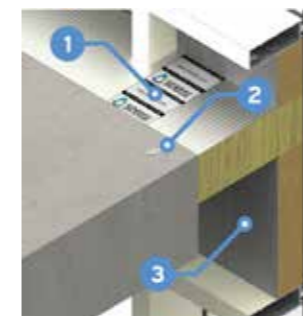
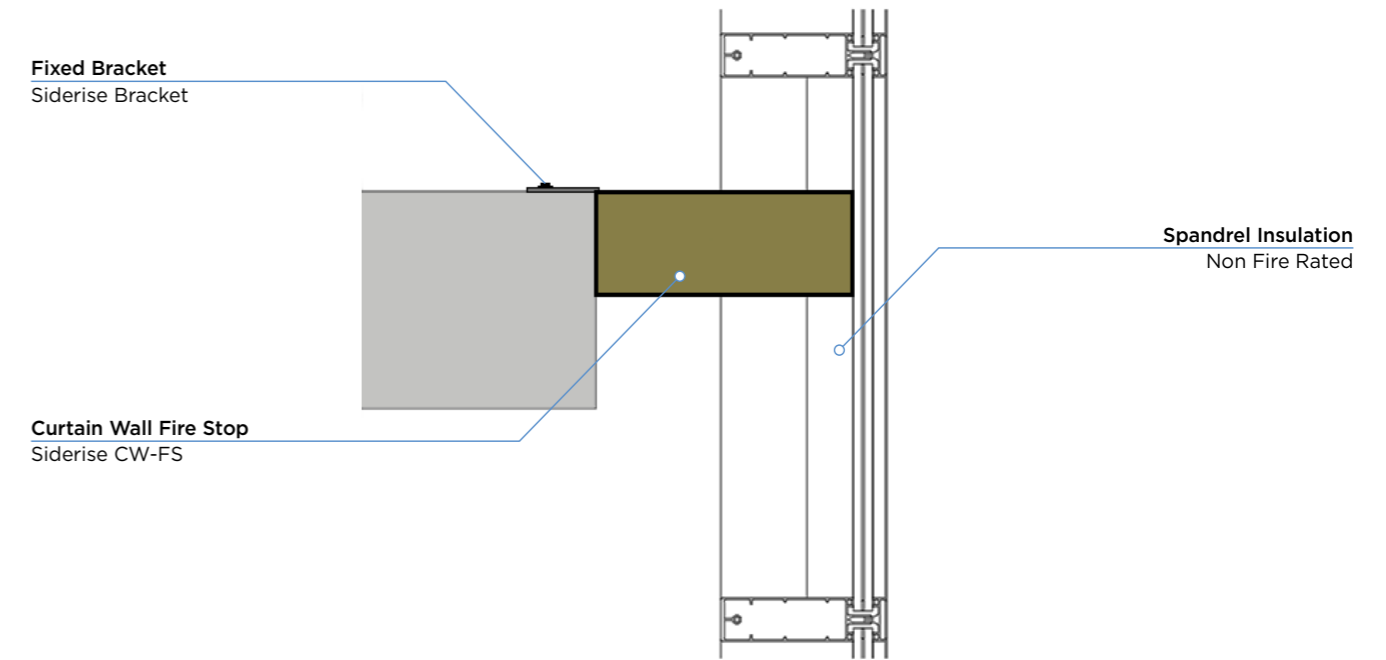
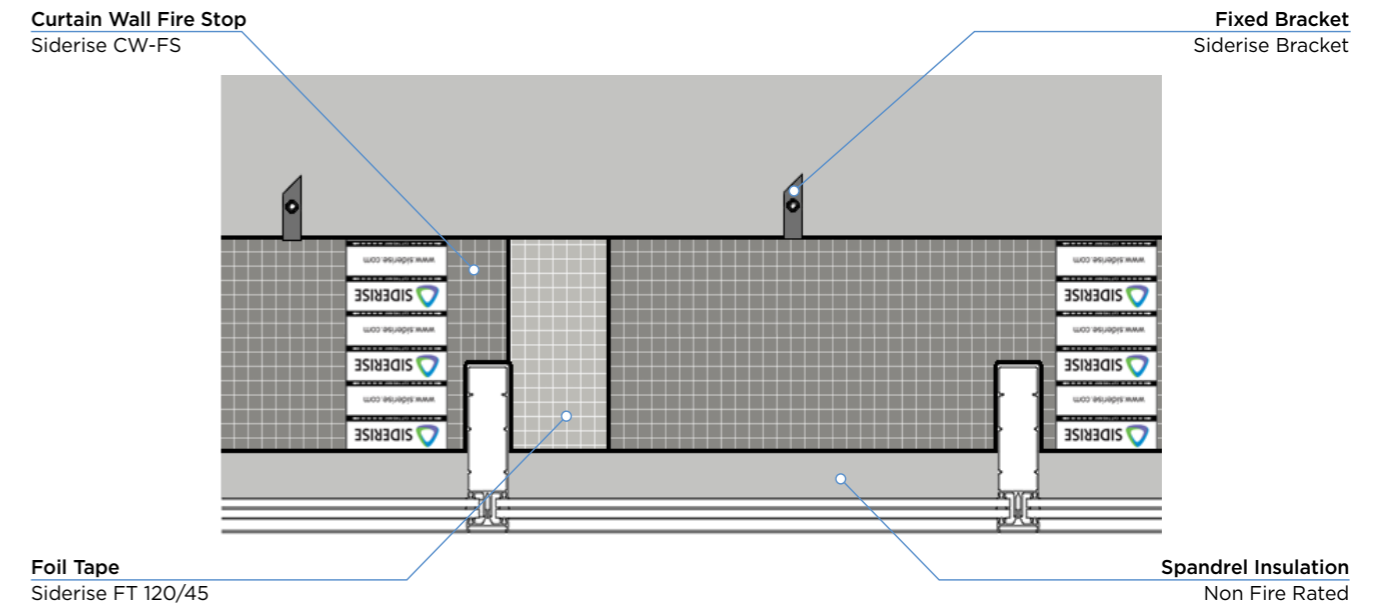

Products used

- 1 Siderise curtain wall fire stop CW-FS
- 2 Siderise support brackets
- 3 Spandrel insulation (non fire rated)



Horizontal perimeter barrier installation: CW-FSH-03-A

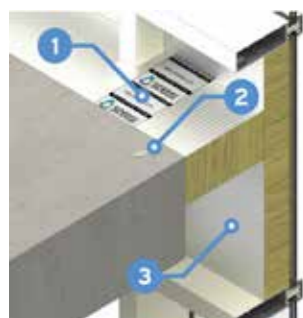
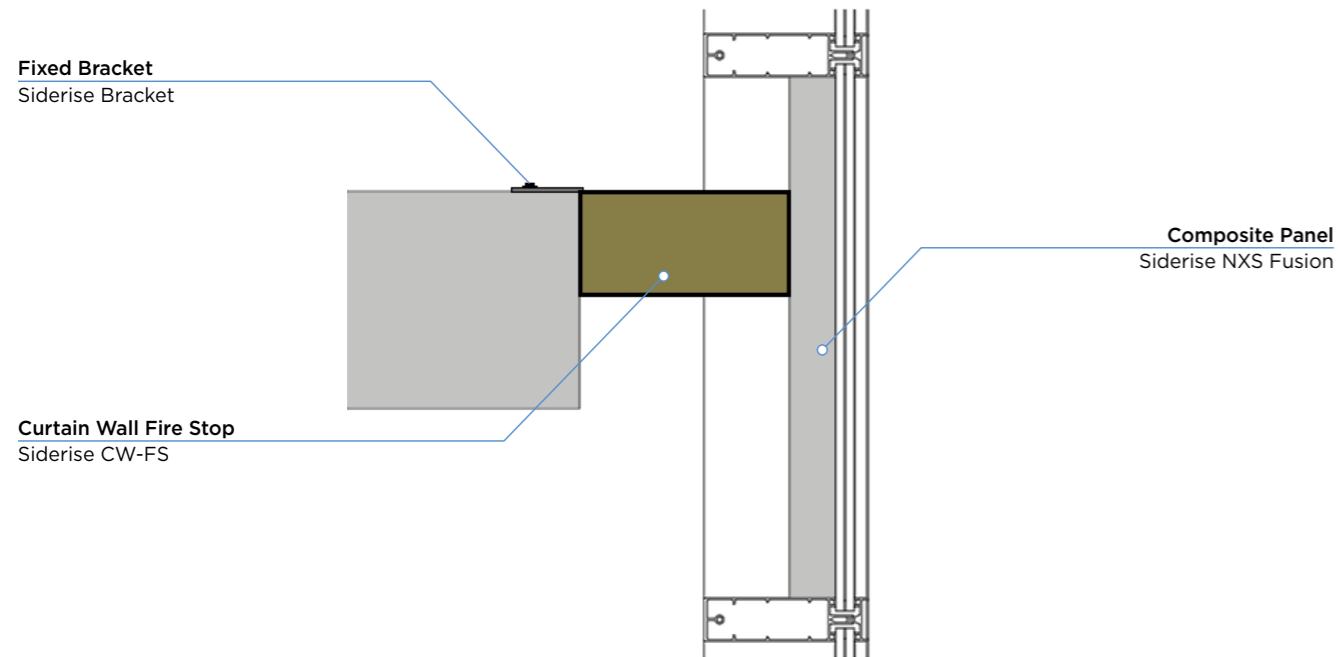
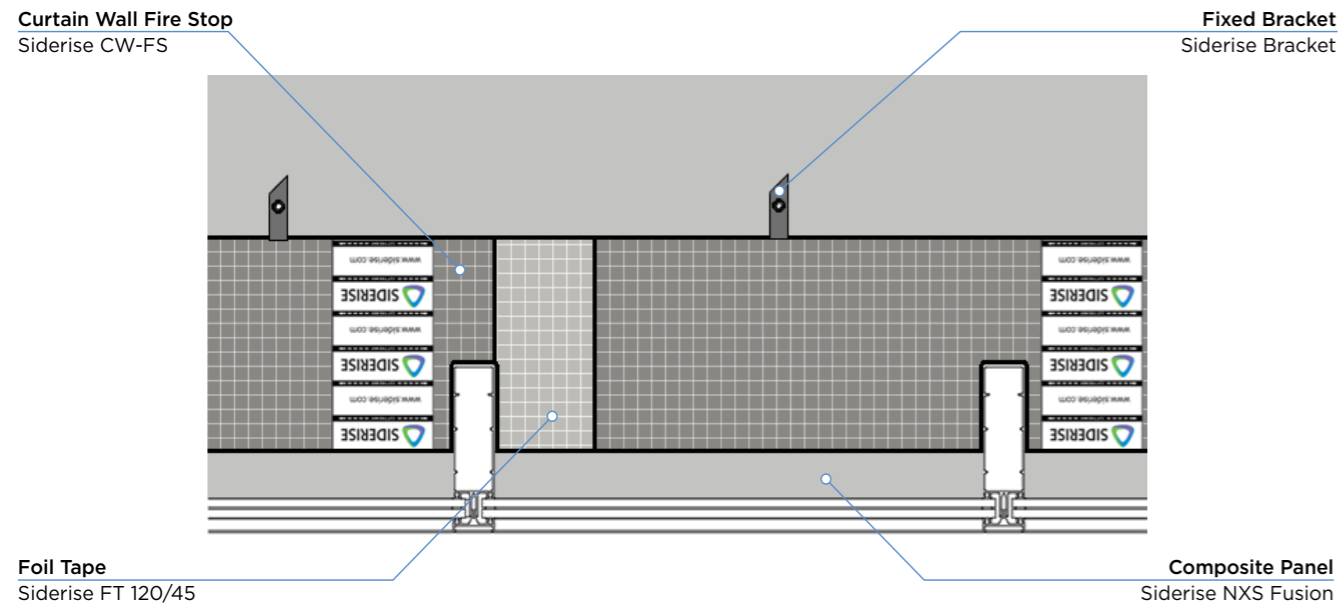

Products used

- 1 Siderise curtain wall fire stop CW-FS
- 2 Siderise support brackets
- 3 Siderise Nexus Fusion 'NXS'

Horizontal perimeter barrier installation: CW-FSH-04-A

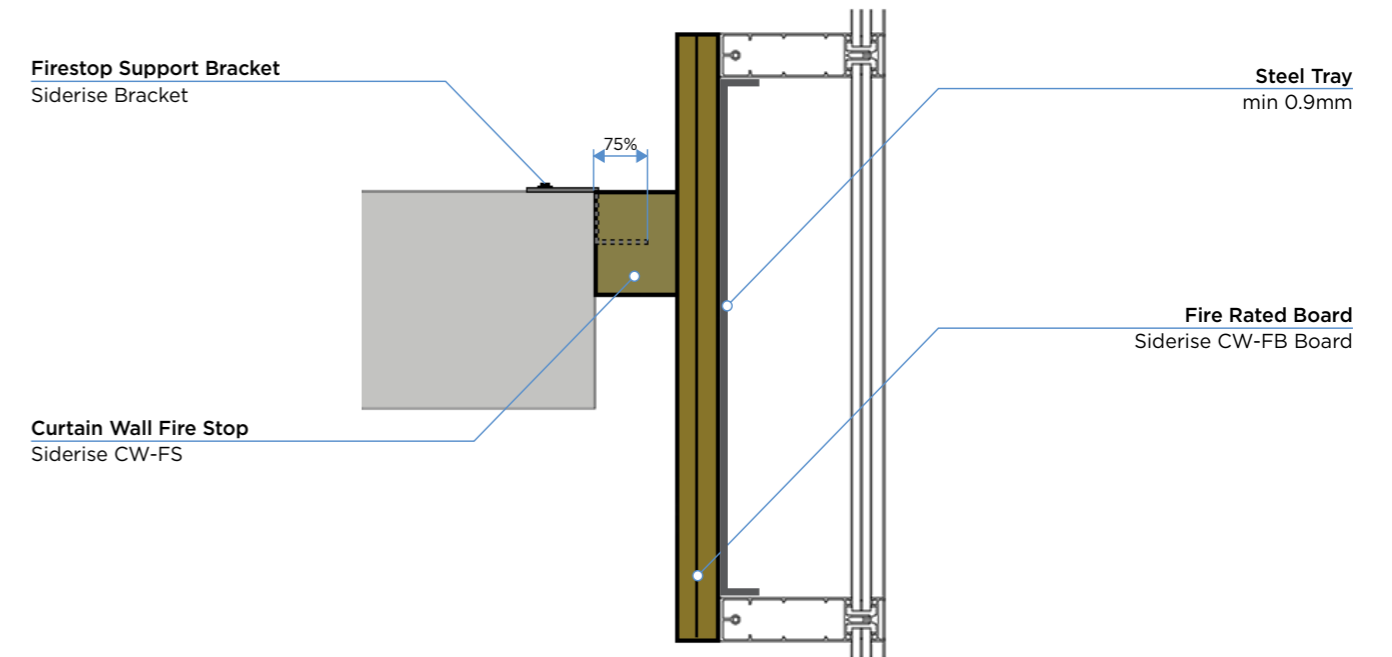
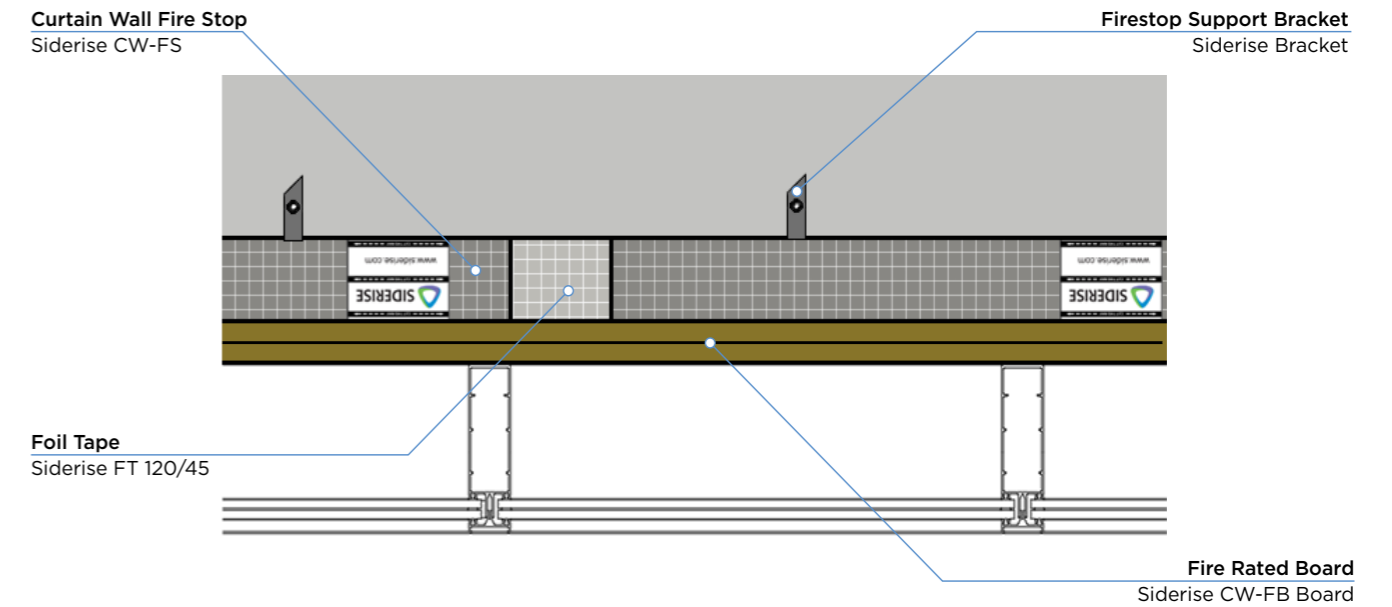

Products used

- 1 Siderise curtain wall fire stop CW-FS
- 2 Siderise support brackets
- 3 Siderise CW-FB Spandrel protection

Horizontal perimeter barrier installation: CW-FSH-03-B

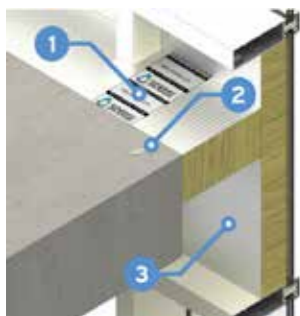
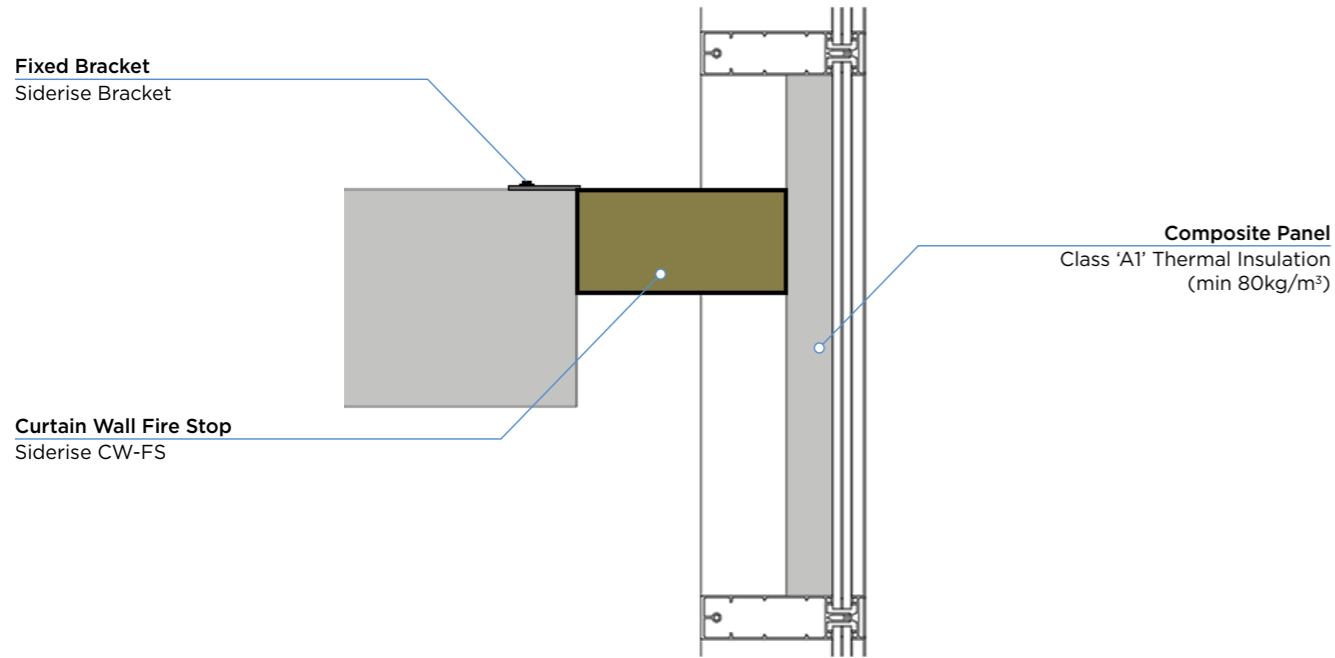
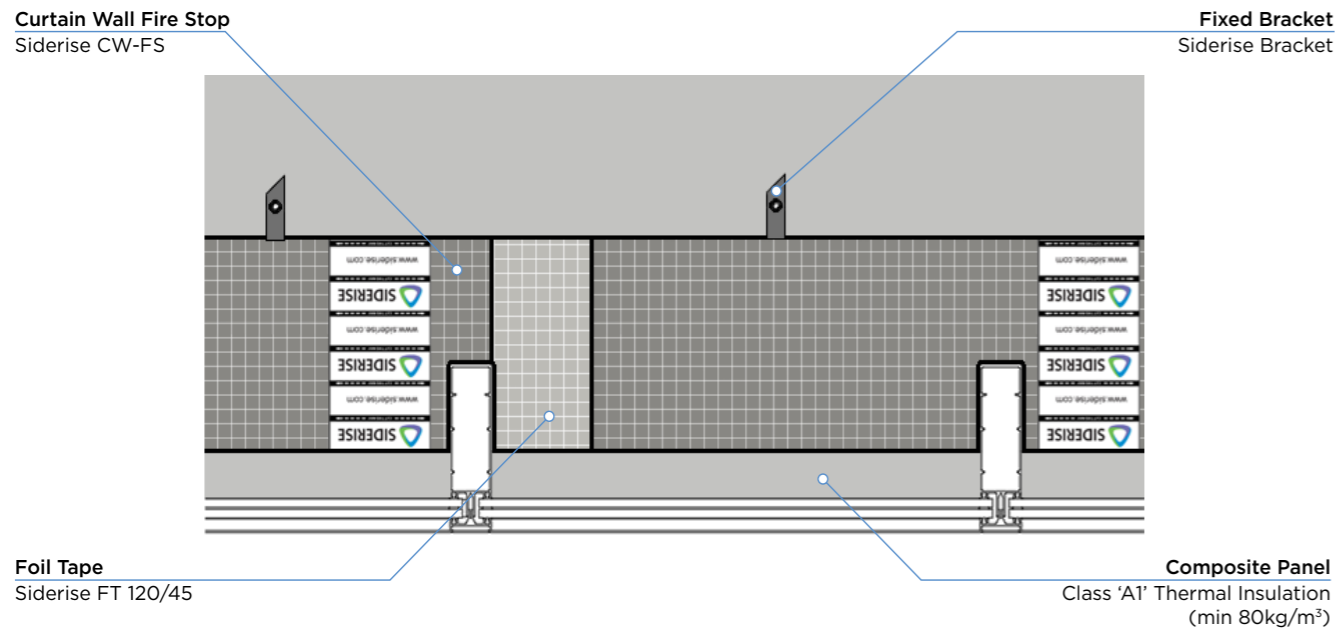

Products used

- 1 Siderise curtain wall fire stop CW-FS
- 2 Siderise support brackets
- 3 Class 'A1' (min 80kg/m³) Thermal Insulation

Horizontal perimeter barrier installation: CW-FSH-04-B

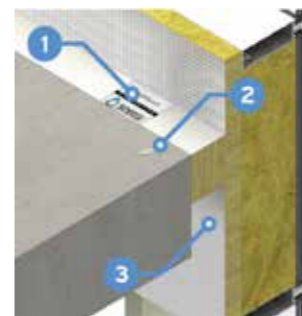
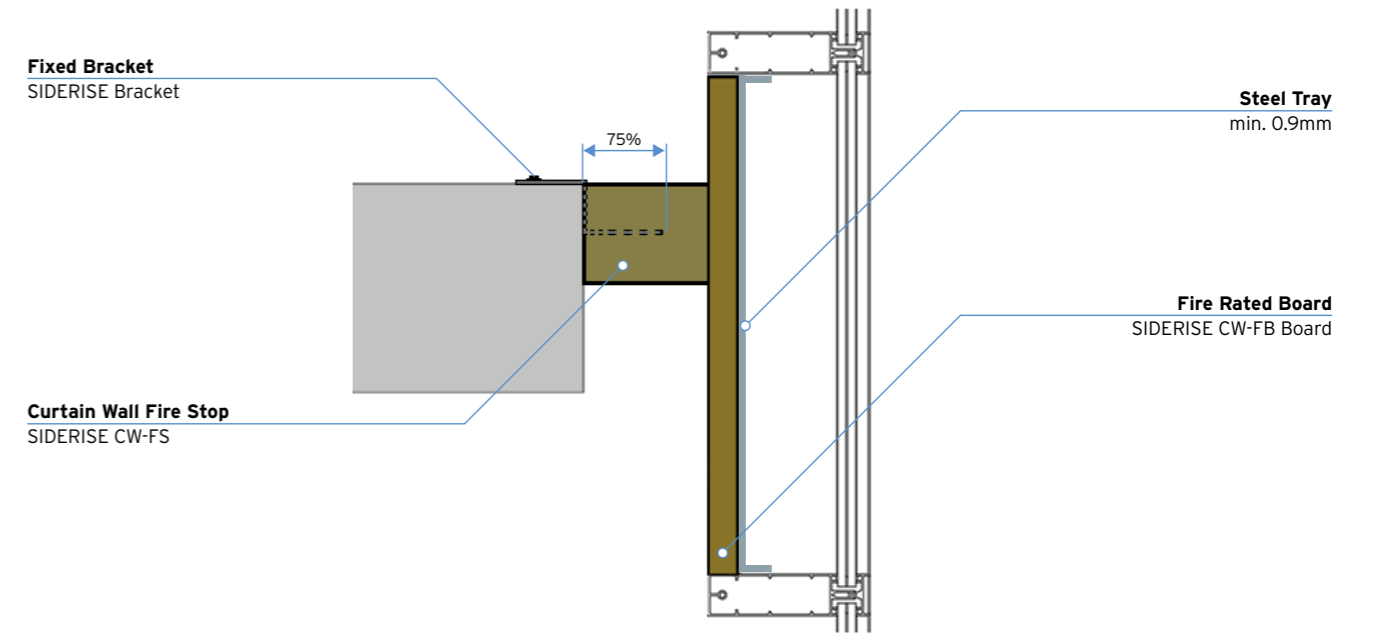
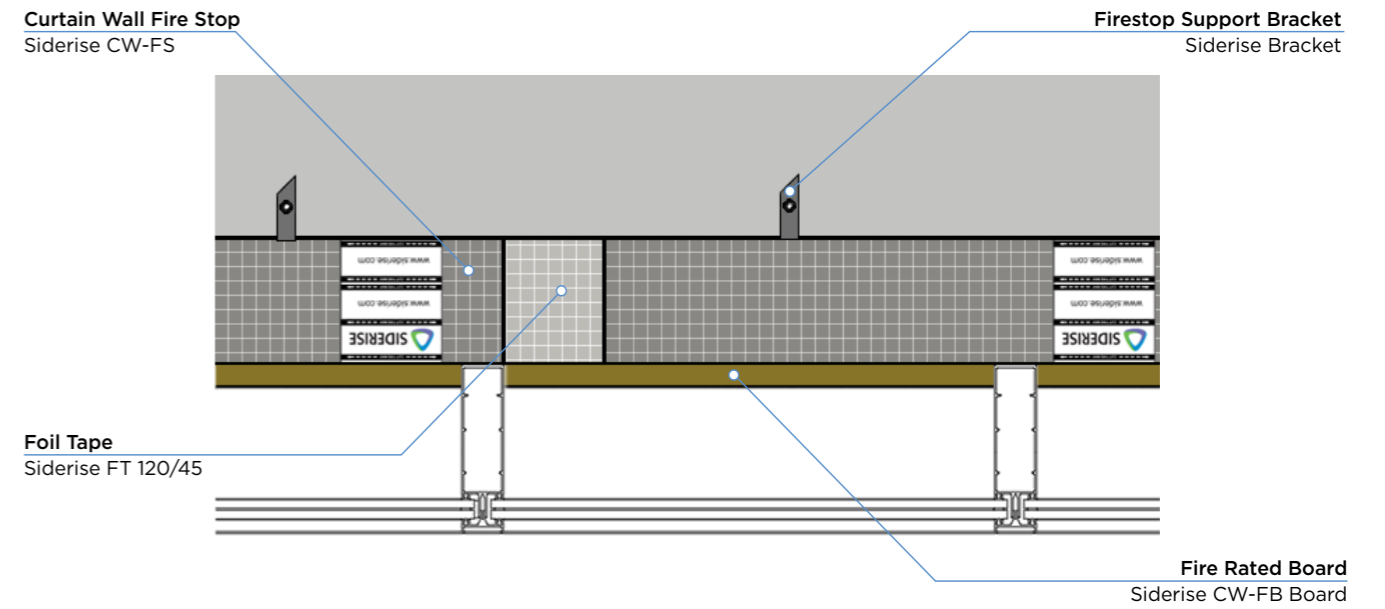

Products used

- 1 Siderise curtain wall fire stop CW-FS
- 2 Siderise support brackets
- 3 Siderise CW-FB Spandrel protection

Horizontal perimeter barrier installation: CW-FSH-05-A

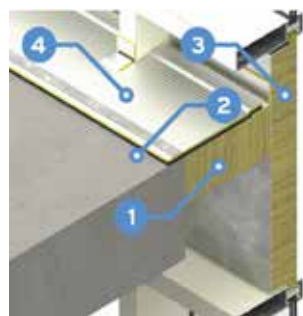
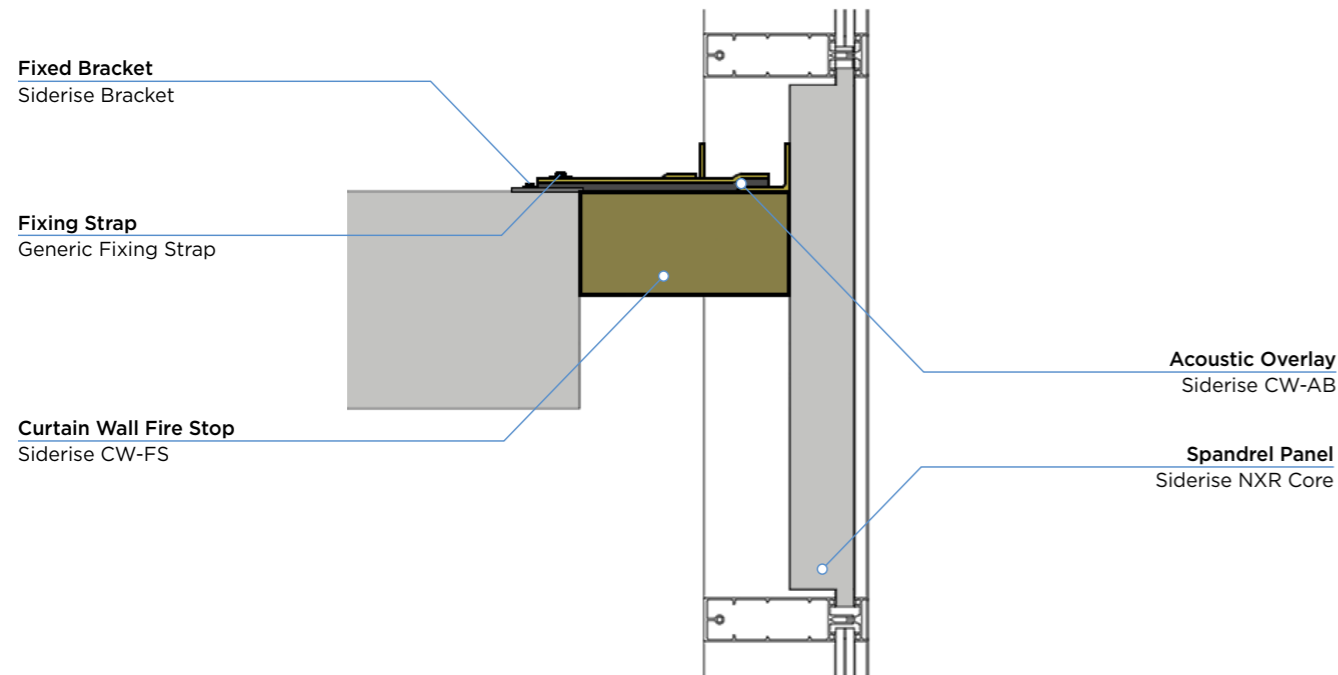
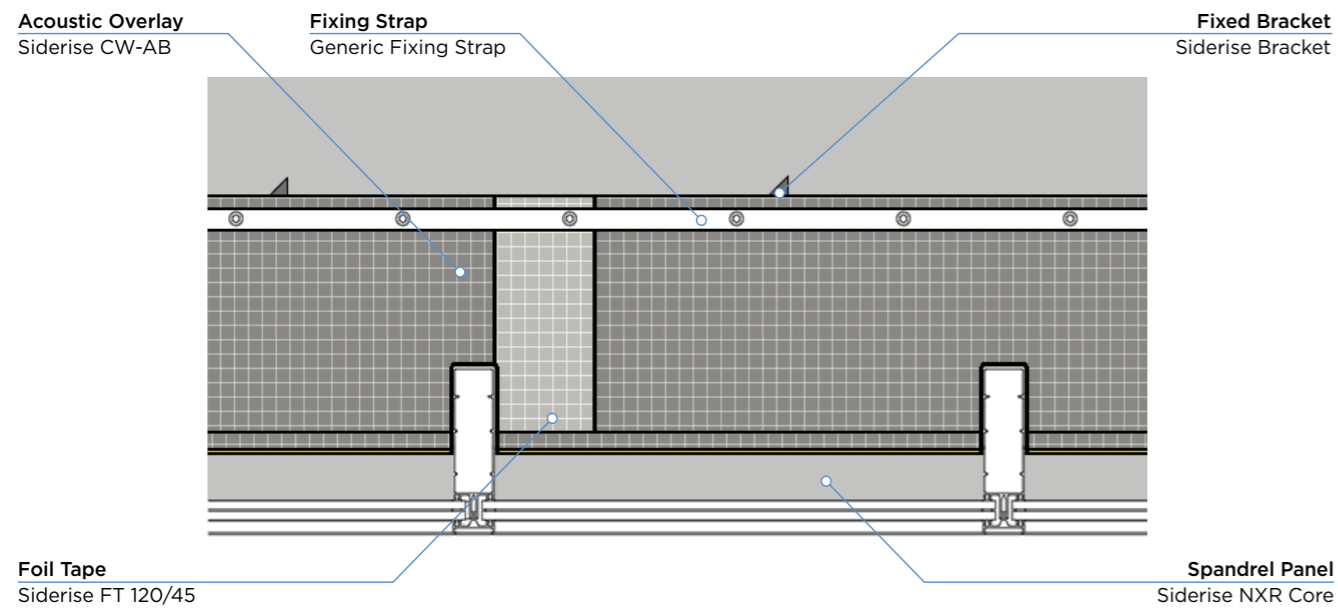

Products used

- 1 Siderise curtain wall fire stop CW-FS
- 2 Siderise support brackets
- 3 Siderise Nexus lamella boards
- 4 Siderise acoustic barrier overlay AB

Horizontal perimeter barrier installation: CW-FSH-06-A

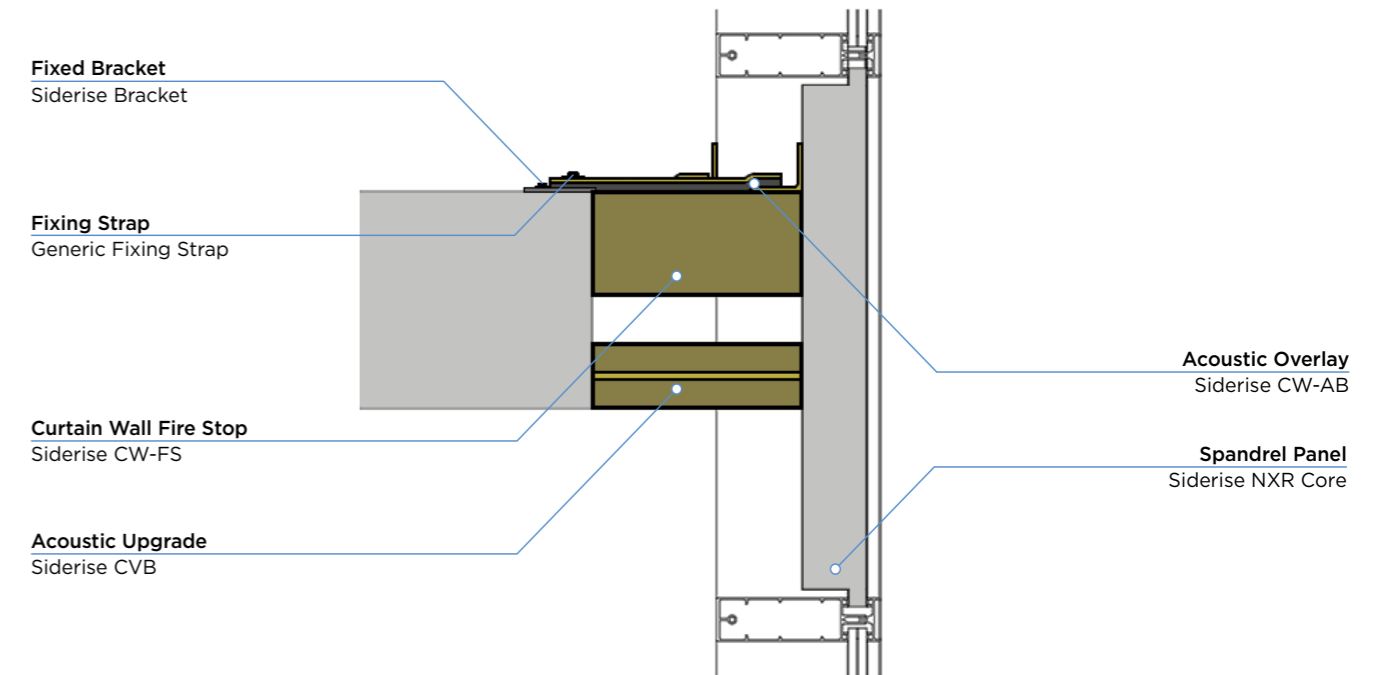
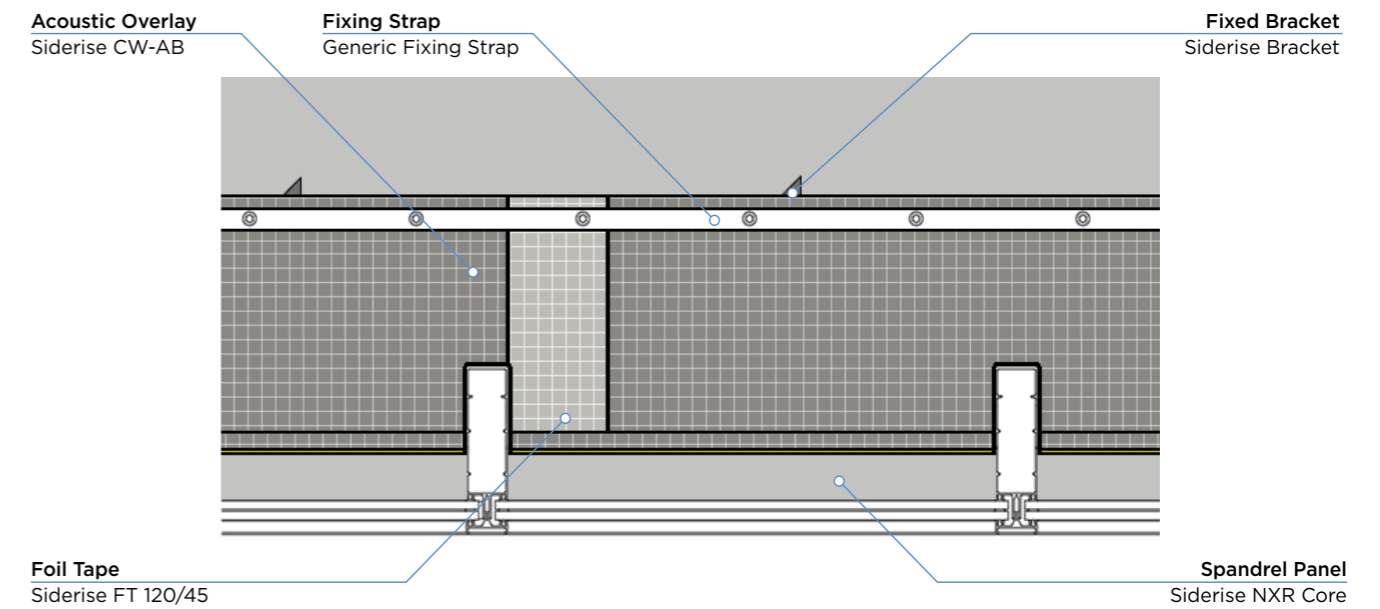

Products used

- 1 Siderise curtain wall fire stop CW-FS
- 2 Siderise support brackets
- 3 Siderise nexus lamella boards
- 4 Siderise acoustic barrier overlay AB
- 5 Siderise acoustic upgrade CVB/C

Horizontal perimeter barrier installation: CW-FSH-07-A

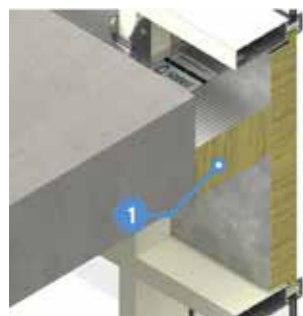
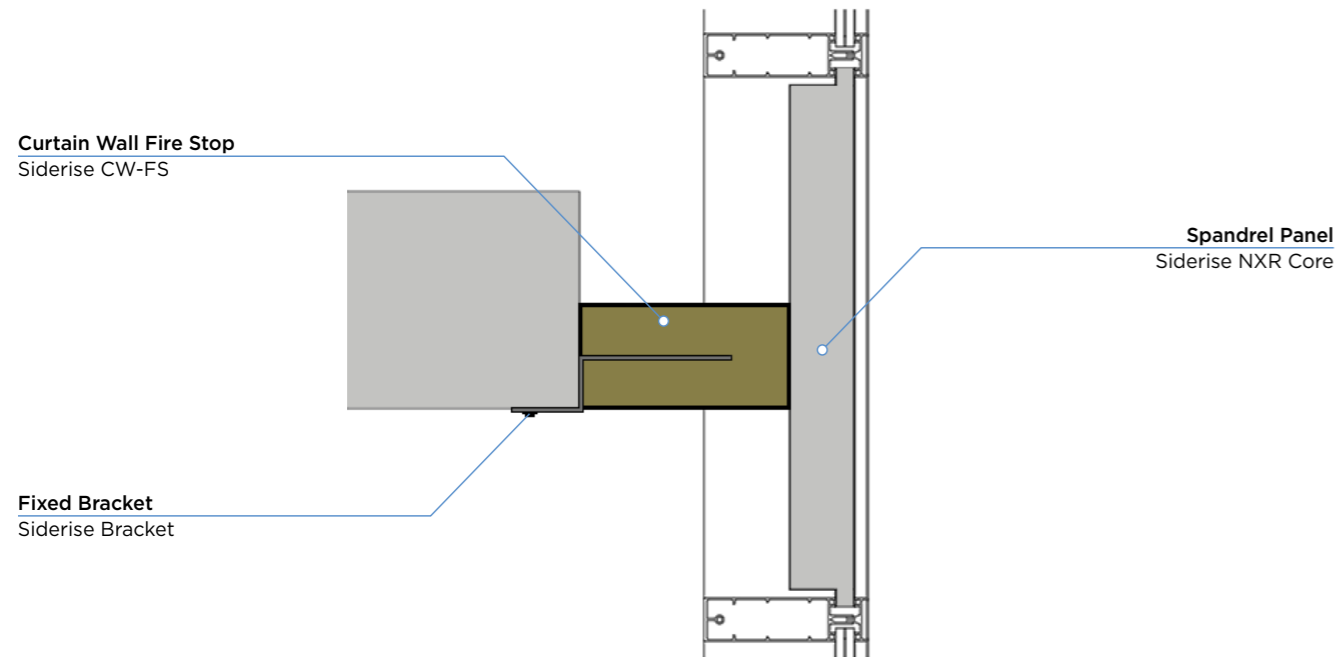
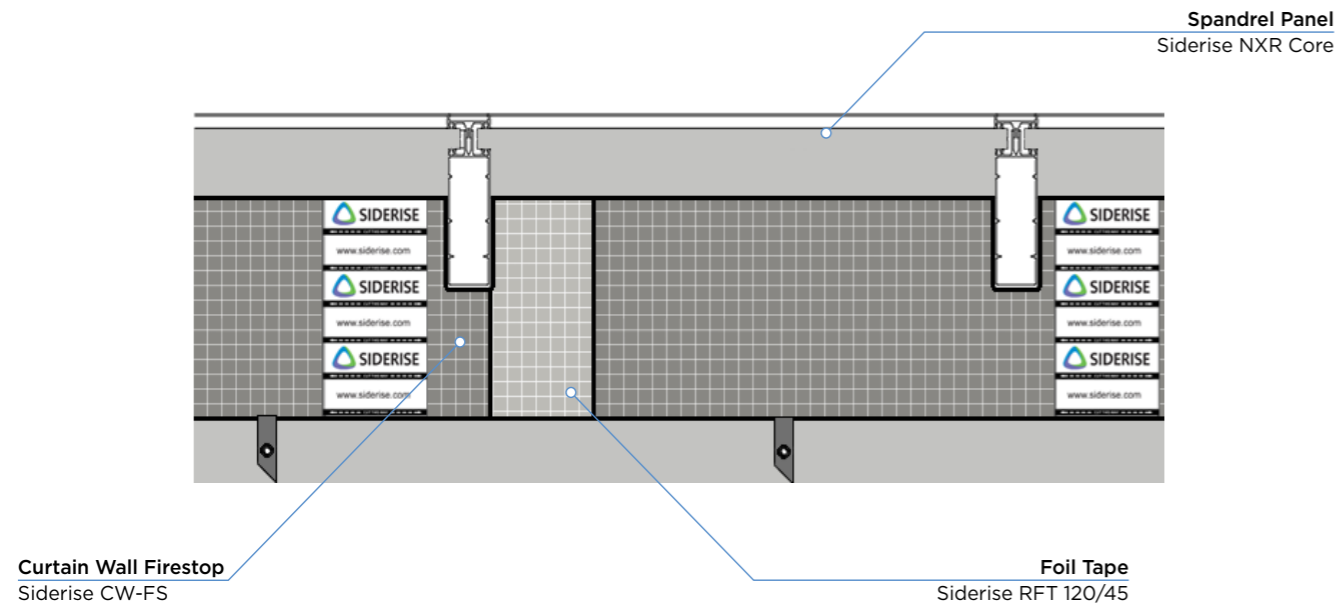

Products used

- 1 Siderise curtain wall fire stop CW-FS

Vertical perimeter barrier installation: CW-FSV-08-A

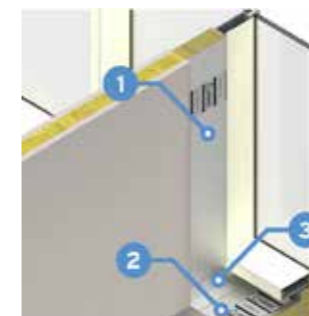
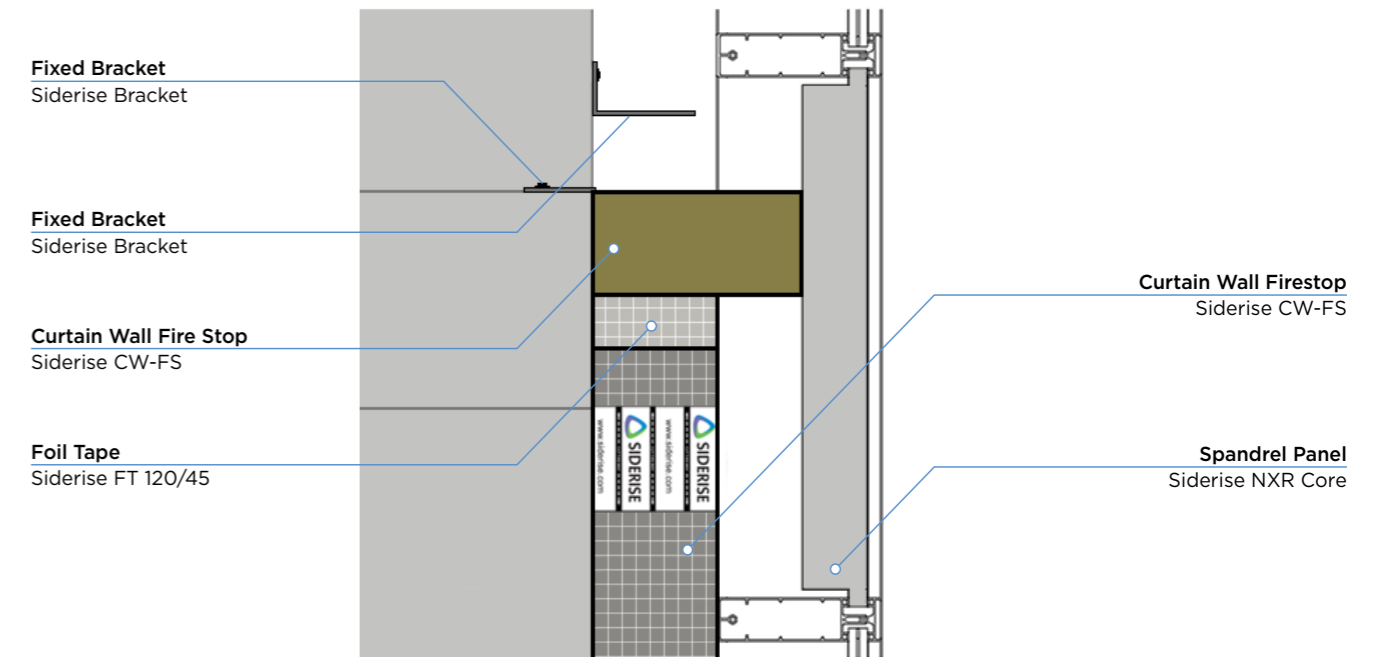
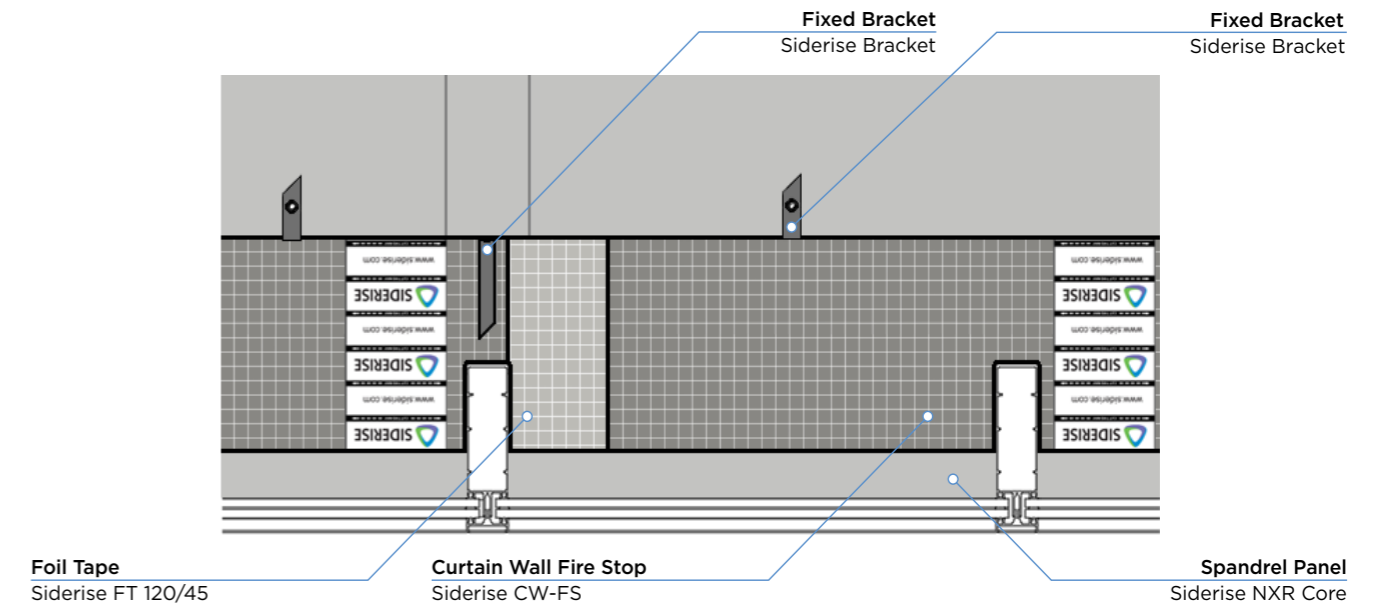

Products used

- 1 Siderise nexus lamella boards
- 2 Siderise curtain wall fire stop CW-FS
- 3 Siderise foil tape: RFT 120/45

Vertical perimeter barrier installation: CW-FS-08-B

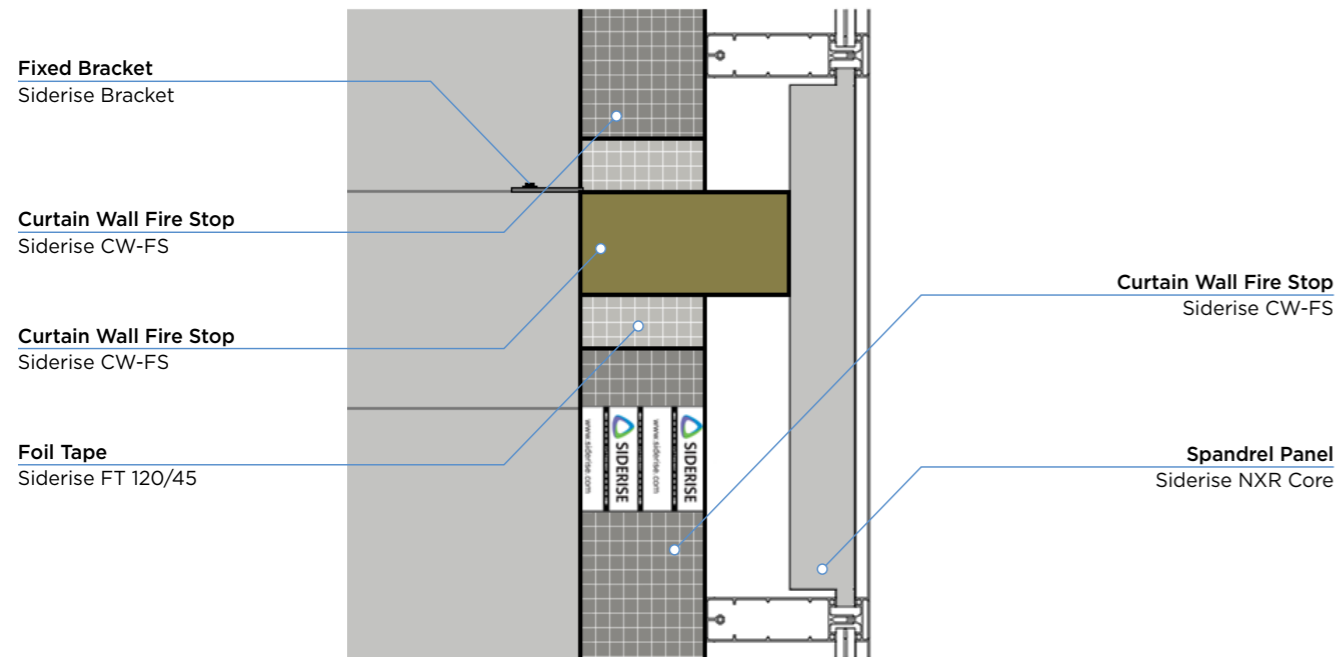
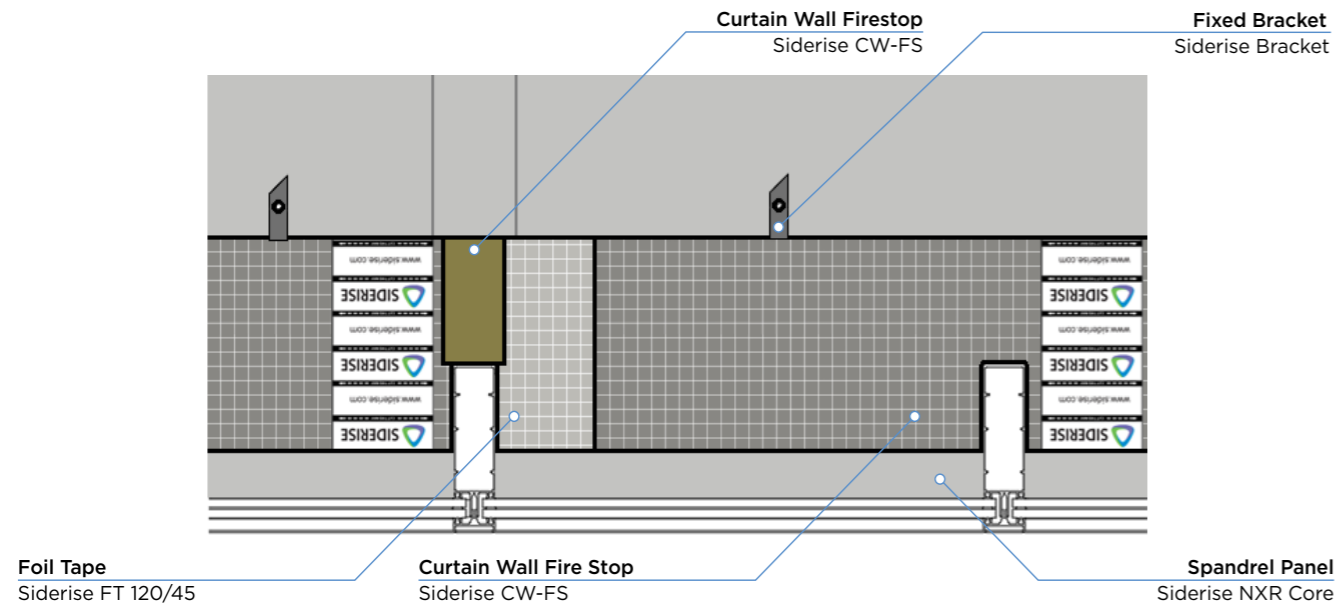

Products used

- 1 Siderise Nexus lamella boards
- 2 Siderise curtain wall fire stop CW-FS
- 3 Siderise foil tape: RFT 120/45

Vertical perimeter barrier installation: CW-FS-08-C

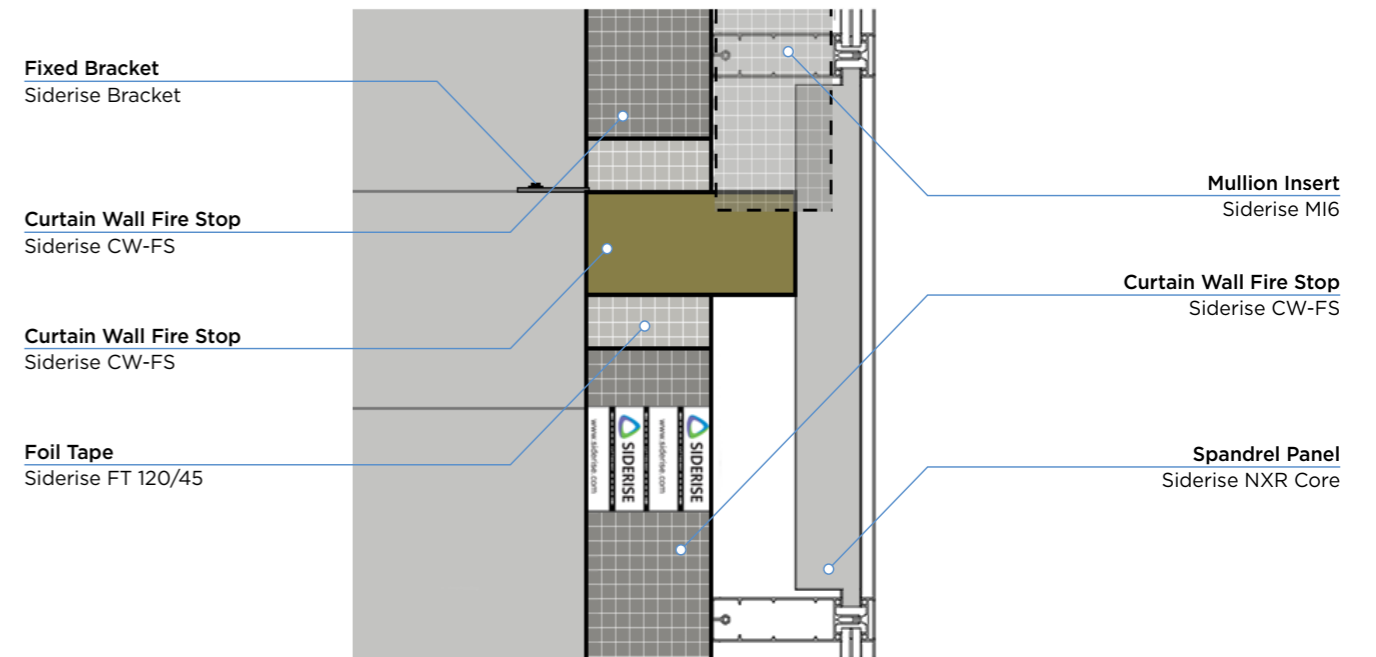
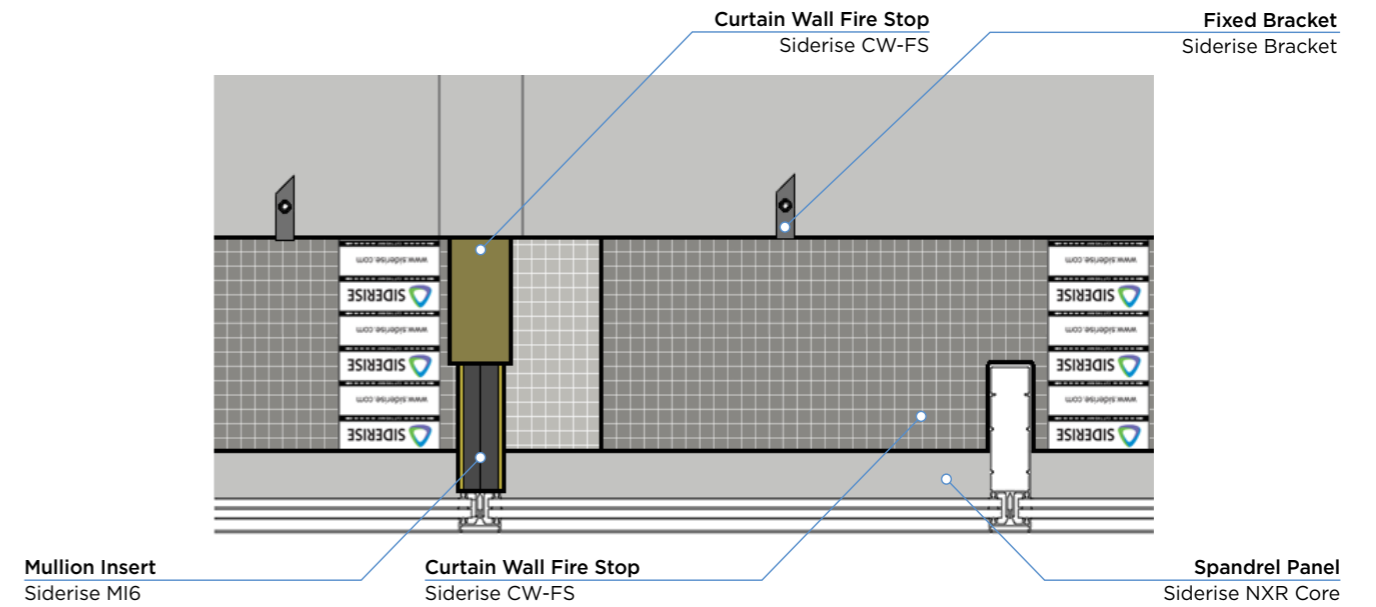

Products used

- 1 Siderise Nexus lamella boards
- 2 Siderise curtain wall fire stop CW-FS
- 3 Siderise foil tape: RFT 120/45

## Regulations guidance

- Approved Document B of the Building Regulations requires that cavity barriers must have a minimum standard fire resistance of 30 minutes integrity and 15 minutes insulation with regards to EN 1366-4 criteria respectively (EI 15).
- The Loss Prevention Council's 'Design Guide for the Fire Protection of Buildings' states that cavity barriers must have 30 minutes integrity and minimum 30 minutes fire insulation (EI 30).
- The 'Standard Performance Criteria' for fire and smoke stopping issued by the Centre for Window and Cladding Technology states: "There shall be continuity of time temperature rated fire and smoke stopping between the curtain wall and compartment walls and floors. Any spaces or cavities between the two shall be effectively stopped against the spread of smoke and flame. The fire resistance of such stopping shall be equal to that required of the compartment floor or wall against which it abuts".

**Siderise CW-CB Cavity Barriers** have been developed in recognition of the more demanding requirements of the 'Design Guide for the Fire Protection of Buildings' as issued by The Loss Prevention Council.

Cavity barriers ... a definition "A construction provided to close a concealed space against penetration of smoke or flame, or provided to restrict the movement of smoke or flame within such a space".

**Siderise CW-CB30** is suitable for use as a cavity barrier (EI 30).

**Siderise CW-FS Fire Stops** are used to maintain the continuity of the fire resistance by sealing the gap between compartment floors (and walls) and the external curtain walling façade or any other external cladding systems.

Fire stops ... a definition "Sealing an imperfection of fit or design tolerance between fire rated elements of a building to restrict the passage of fire and smoke for the same period of fire resistance".

For the purpose of Siderise product terminology, the 'imperfection of fit' is considered to be the discontinuity between the edge of the structural frame (slab or wall) and the interface with the external cladding system.

**Siderise CW-FS60** is suitable for installation in alignment with a 1 hour rated compartment wall or floor to provide continuity of fire resistance across the cavity (EI 60).

**Siderise CW-FS120** is suitable for installation in alignment with a 90 minute or 2 hour rated compartment wall or floor (EI 120).

**Siderise CW-FS180** is suitable for installation in alignment with a 3 hour compartment floor (EI 180).

## FURTHER INFORMATION

### Products available

The following Siderise products are available.

- **Siderise CW** perimeter barriers and fire stops for curtain walling – sheet or pre-cut strip options
- **Siderise Aluminium Jointing Tape** must be used at all joints and intersections: RFT120/45 (120mm wide x 45m rolls) Adhesive backed, Supplied in boxes of 8
- **Siderise Fire & Acoustic Sealant** may be used for small gaps and undulations: FS120/310ML/WH (310ml cartridge) Supplied in boxes of 25

### Additional information available

The following information is available for download via the website:

- NBS Specification Clause
- Safety Data Sheet
- Cutting and Installation instructions
- 3rd party approval - Certifire 'CF 563'
- 3rd party approval - Intertek 'WHI9-32944301'
- 3rd party approval - Intertek 'WH20-32944302'

### Ordering

When ordering please:

- Indicate contract title and location of project.
- Specify product type required, e.g. sheet form.
- Specify fire rating or thickness required.
- Specify void height or schedule of sizes for each product type.
- Confirm total linear metres required for each size.
- Specify bracket type and quantity required
- Specify foil tape quantity requirement: RFT 120/45.
- Order Siderise fire and acoustic gap sealant 310ml cartridge

### Environmental

Siderise perimeter barriers and fire stops for curtain walling are environmentally friendly.

- They contain no Volatile Organic Compounds (VOCs) and no very Volatile Organic Compounds (vVOCs).
- Zero Ozone Depleting Potential
- Zero Global Warming Potential
- Recyclable

### Specification support

Siderise offer specifiers support from initial enquiry and technical consultation to project realisation. NBS draft specifications are provided for standard products and applications and can be tailored to suit specific project performance requirements.

### Technical & Sales support

#### Sales support

##### Sales Team

T: +44 (0) 1656 730833  
E: enquiries@siderise.com

#### Technical support

##### Technical Services Team

T: +44 (0) 1656 730833  
E: technical.services@siderise.com

#### Site Services support

Siderise offer a range of services to contractors and installers. These include toolbox product installation and site installation inspection and reporting (subject to availability and by agreement).

##### Site Services Team

T: +44 (0) 1656 730833  
E: site.services@siderise.com

#### System testing support

Siderise can provide assistance and advice for large scale system testing to BS EN, NFPA, ASTM and AS standards.

##### Testing Support Team

T: +44 (0) 1656 730833  
E: firetesting@siderise.com

#### Context

The information in this datasheet is believed to be accurate at the date of publication. Siderise has a policy of continuous product improvement and reserves the right to alter or amend the specifications of products without prior notice. Siderise does not accept responsibility for the consequences of using the products described outside of the recommendations within this datasheet. Expert advice should be sought where there is any doubt about the correct specification or installation of Siderise products.

## Technical specification

### Siderise Perimeter Barriers & Fire stops for Curtain Walling

<b>Form supplied</b>	Sheet : 1200mm x 1200mm x thickness (denoted by rating)  Pre-cut strips : 1200mm x (cavity + compression as per Certifire/Intertek) x thickness - please see tables 1 to 3
<b>Colour</b>	Silver, with coloured identification tape centrally located on the product
<b>Finish</b>	Aluminium foil
<b>Density</b>	Nominal 75 kg/m <sup>3</sup>
<b>Thermal conductivity</b>	$\lambda_{10} = 0.038$ W/m.K (tested foil to foil)
<b>Cavities</b>	20mm to 600mm - please see tables 1 to 3
<b>Reaction to fire</b>	EN 13501-1 : Class 'A1'
<b>Resistance to fire</b>	EN 13501-2 : EI 30 to EI 180 (minutes) - please see tables 1 to 3

# BY YOUR SIDE®

## **Siderise Insulation**

Passive fire solutions for the building envelope

### **United Kingdom**

Siderise Group, Forge Industrial Estate,  
Maesteg, UK, CF34 0AY

T: +44 (0) 1656 730833 | F: +44 (0) 1656 812509

### **Middle East & India**

Siderise Middle East, FZ LLP, Office 3710,  
The Citadel Tower, Business Bay, Dubai, UAE

T: +971 (0) 4 580 4999

### **Asia Pacific**

Siderise (Asia Pacific) Pte. Ltd. 80 Robinson Road,  
#02-00 Singapore 068898

T: +65-963 19310

[www.siderise.com](http://www.siderise.com)

## **Siderise Special Products**

Engineered acoustic solutions for equipment manufacture and construction

### **Siderise (Special Products) Ltd**

Lady Lane Industrial Estate  
Hadleigh, Suffolk, IP7 6BQ

T: +44 (0) 1473 827695

